

Description

This 80V,100A N-Channel MOSFET in a TO-263 Plastic Package.

Applications

These devices are well suited for high efficiency switching DC/DC converters and switch mode power supplies.

Features

- Low gate charge
- Low crss
- Fast switching
- Halogen-free Product

V_{DSS}	$R_{DS(on)}$ (Typ)	I_D
80V	6.5mΩ	100A

Equivalent Circuit & Pinning

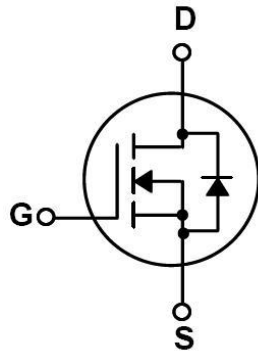

Pin1:Gate

Pin2:Drain

Pin3:Source

Maximum Ratings(Ta=25°C)

Parameter	Symbol	Rating	Unit
Drain-Source Voltage	V_{DSS}	80	V
Drain Current	$I_D(T_C=25^\circ\text{C})$	100	A
Drain Current	$I_D(T_C=100^\circ\text{C})$	72	A
Peak Drain Current	I_{DM}	320	A
Gate-Source Voltage	V_{GSS}	± 20	V
Repetitive Avalanche Energy	E_{AS}	1164	mJ
Repetitive Avalanche Energy	E_{AR}	13.1	mJ
Avalanche Current	I_{AR}	75	A
Total Power Dissipation	$P_D(T_C=25^\circ\text{C})$	165	W
Junction and Storage Temperature Range	T_J, T_{STG}	-55 to 150	°C

Electrical Characteristics(Ta=25°C)

Parameter	Symbol	Test Conditions	Min	Typ	Max	Unit
Zero Gate Voltage Drain Current	BV_{DSS}	$V_{GS}=0V$ $I_D=250\mu A$	80			V
Zero Gate Voltage Drain Current	I_{DSS}	$V_{DS}=80V$ $V_{GS}=0V$			1	μA
		$V_{DS}=80V$ $V_{GS}=0V$ $T_C=125^\circ\text{C}$			10	μA
Gate-Body Leakage Current Forward	I_{GSS}	$V_{GS}=\pm 20V$ $V_{DS}=0V$			± 0.1	μA
Gate Threshold Voltage	$V_{GS(th)}$	$V_{DS}=V_{GS}$ $I_D=250\mu A$	2		4	V
Static Drain-Source On-Resistance	$R_{DS(on)}$	$V_{GS}=10V$ $I_D=40A$		6.5	8	m Ω
Forward Transconductance	g_{FS}	$V_{DS}=5V$ $I_D=30A$		58		S
Forward On Voltage	V_{SD}	$V_{GS}=0V$ $I_S=40A$			1.3	V
Input Capacitance	C_{iss}	$V_{GS}=0V$ $f=1\text{MHz}$ $V_{DS}=25V$		320		pF
Output Capacitance	C_{oss}			330		pF
Reverse Transfer Capacitance	C_{rss}			260		pF
Turn-On Delay Time	$t_{d(on)}$	$V_{DD}=30V$ $I_D=2A$ $R_L=25\Omega$ $V_{GS}=10V$ $R_G=25\Omega$		20		ns
Turn-On Rise Time	t_r			17.8		ns
Turn-Off Delay Time	$t_{d(off)}$			76.8		ns
Turn-Off Fall Time	t_f			15.7		ns

Electrical Characteristic Curve

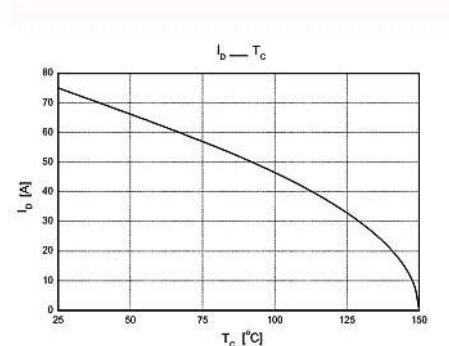
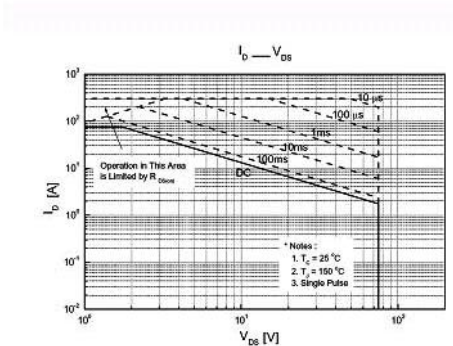
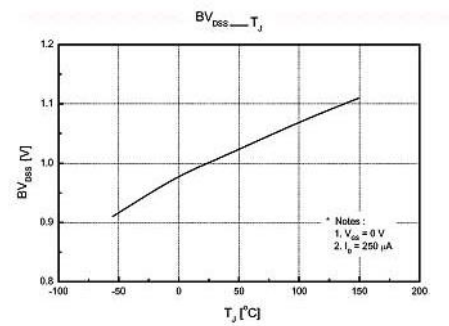
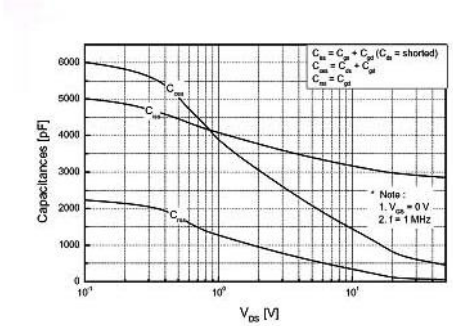
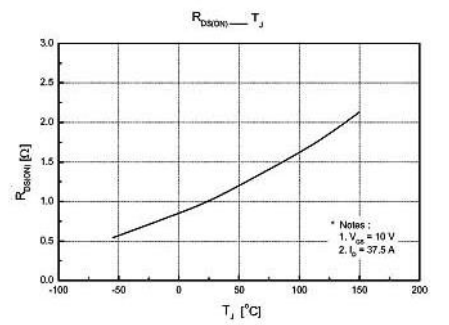
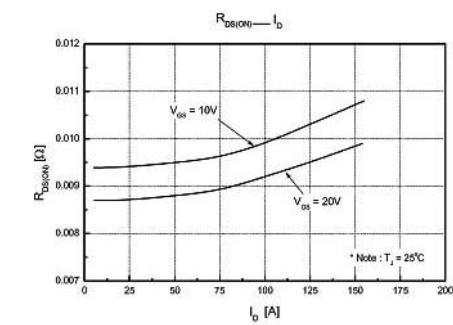
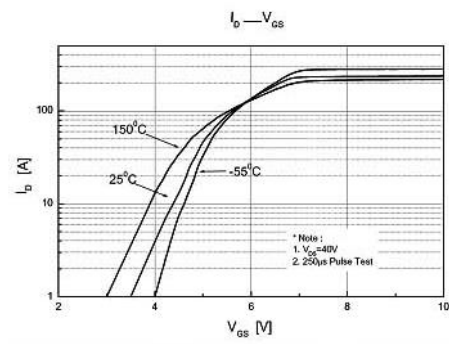
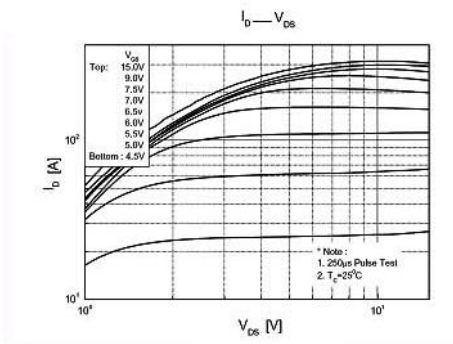

Marking Instructions

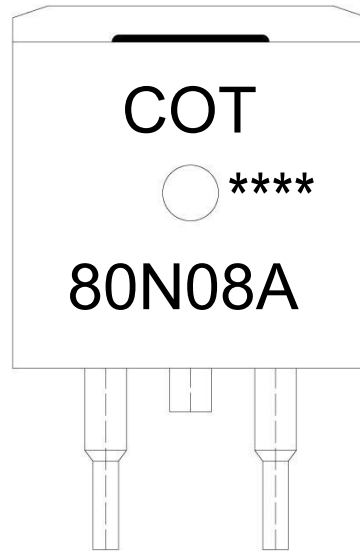

Note:

COT: Company Code

80N08A: Product Type.

****: Lot No. Code, code change with Lot No.

Packaging SPEC.

REEL INFORMATION

Package Type	Units					Dimension (unit: mm ³)		
	Units/Reel	Reels/Inner Box	Units/Inner Box	Inner Boxes/Outer Box	Units/Outer Box	Reel	Inner Box	Outer Box
TO-263	800	1	800	5	4,000	13" x24	360x360x50	385x257x392

TUBE INFORMATION

Package Type	Units					Dimension (unit: mm ³)		
	Units/Tube	Tubes/Inner Box	Units/Inner Box	Inner Boxes/Outer Box	Units/Outer Box	Tube	Inner Box	Outer Box
TO-263	50	20	1,000	5	5,000	532x33x7.0	555x164x50	575x290x180

Package Outline Dimensions

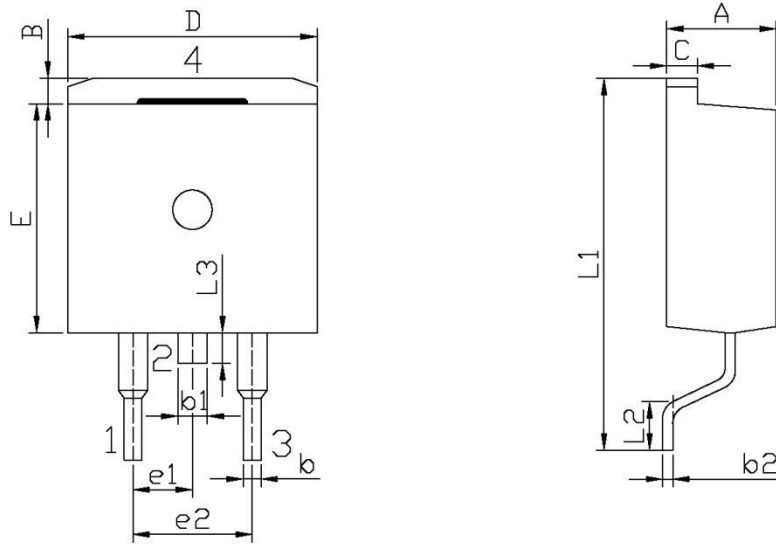

单位: mm

Symbol	Dimensions In Millimeters		Symbol	Dimensions In Millimeters	
	Min	Max		Min	Max
A	4.30	4.70	E	9.00	9.40
B	1.00	1.40	e1	2.34	2.74
b	0.70	0.90	e2	4.88	5.28
b1	1.15	1.35	L1	15.00	16.00
b2	0.40	0.60	L2	2.24	2.84
C	1.20	1.40	L3	1.20	1.60
D	9.80	10.20			

T0-263