

Description

- This is Silicon Diode in a SOT-23 Plastic Package.

Features

- Small signal diode
- Halogen-free product

Applications

- High Conductance Ultra Fast Diode

V_{RRM}	I_{FM}	I_{FSM}
80 V	200mA	1A

Equivalent Circuit

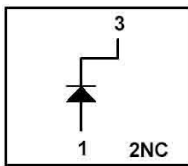

Pinning



PIN: See Equivalent Circuit.

Marking

Marking	HA6
---------	-----

Absolute Maximum Ratings(Ta=25°C)

Parameter	Symbol	Rating	Unit
Maximum Repetitive Reverse Voltage	V_{RRM}	85	V
Average Rectified Forward Current	$I_{F(AV)}$	200	mA
Non-repetitive Peak Forward Surge Current	$I_{FSM(1)(PW=1S)}$	1.0	A
	$I_{FSM(2)(PW=1mS)}$	2.0	A
Power Dissipation	P_D	350	mW
Thermal Resistance, Junction to Ambient	$R_{\theta JA}$	357	°C/W
Junction Temperature	T_j	150	°C
Storage Temperature Range	T_{stg}	-55~150	°C

Electrical Characteristics(Ta=25°C)

Parameter	Symbol	Test Conditions	Min	Typ	Max	Unit
Breakdown Voltage	V_R	$I_R=5.0\mu A$	85			V
Forward Voltage	V_F	$I_F=1.0mA$			715	mV
		$I_F=10mA$			855	mV
		$I_F=50mA$			1.0	V
		$I_F=150mA$			1.25	V
Instantaneous Reverse Current	I_R	$V_R=75V$			1.0	μA
		$V_R=25V$ $T_A=150^\circ C$			30	μA
		$V_R=75V$ $T_A=150^\circ C$			50	μA
Total Capacitance	C_T	$V_R=0$ $f=1.0MHz$			2.0	pF
Reverse Recovery Time	t_{rr}	$I_F=I_R=10mA$ $I_{RR}=1.0mA$ $R_L=100\Omega$			6.0	ns

Electrical Characteristic Curve

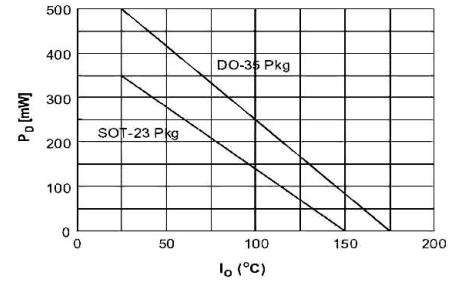
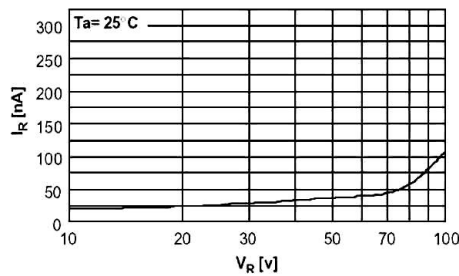
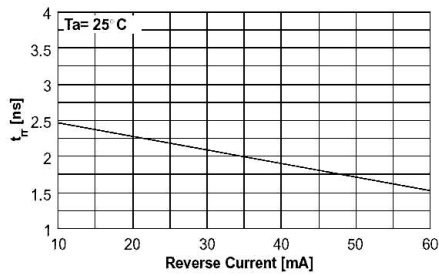
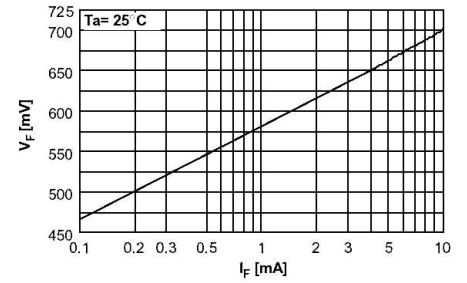
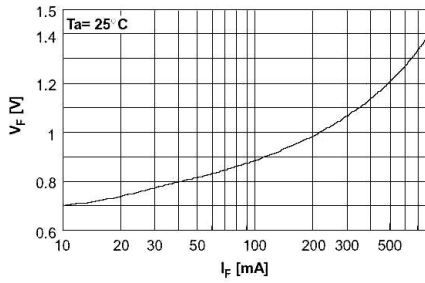
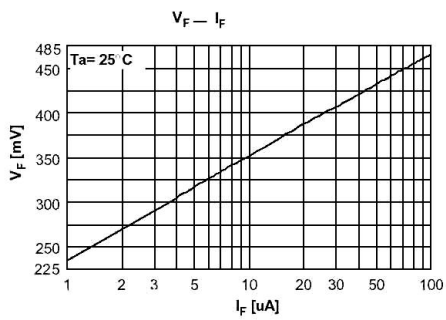
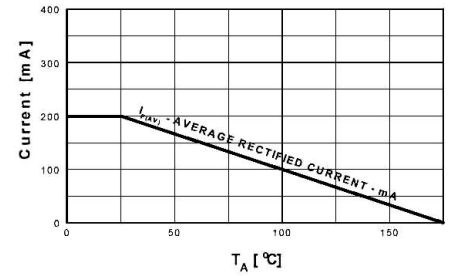
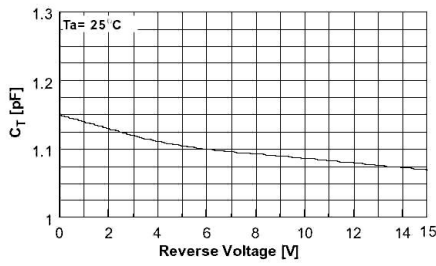
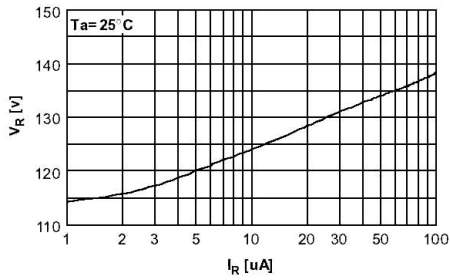

Marking Instructions

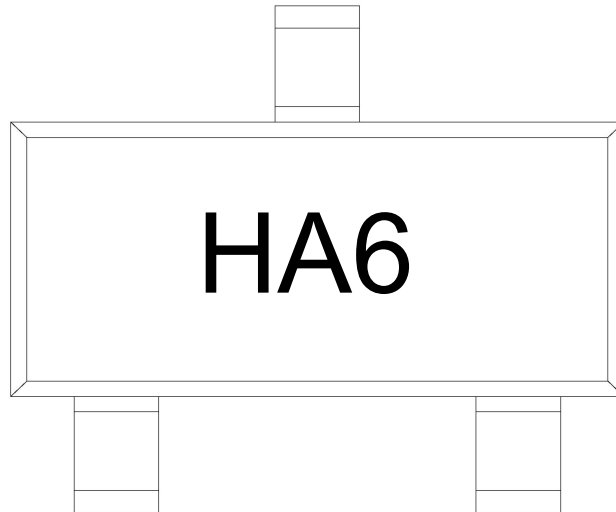

Note:

H: Company Code.

A6: Product Type.

Packaging SPEC.

REEL

Package Type	Units					Dimension (unit: mm ³)		
	Units/Reel	Reels/Inner Box	Units/Inner Box	Inner Boxes/Outer Box	Units/Outer Box	Reel	Inner Box	Outer Box
SOT-23	3,000	10	30,000	8	240,000	7" x8	180×120×180	385×257×392

Package Dimensions

SOT-23

单位: mm

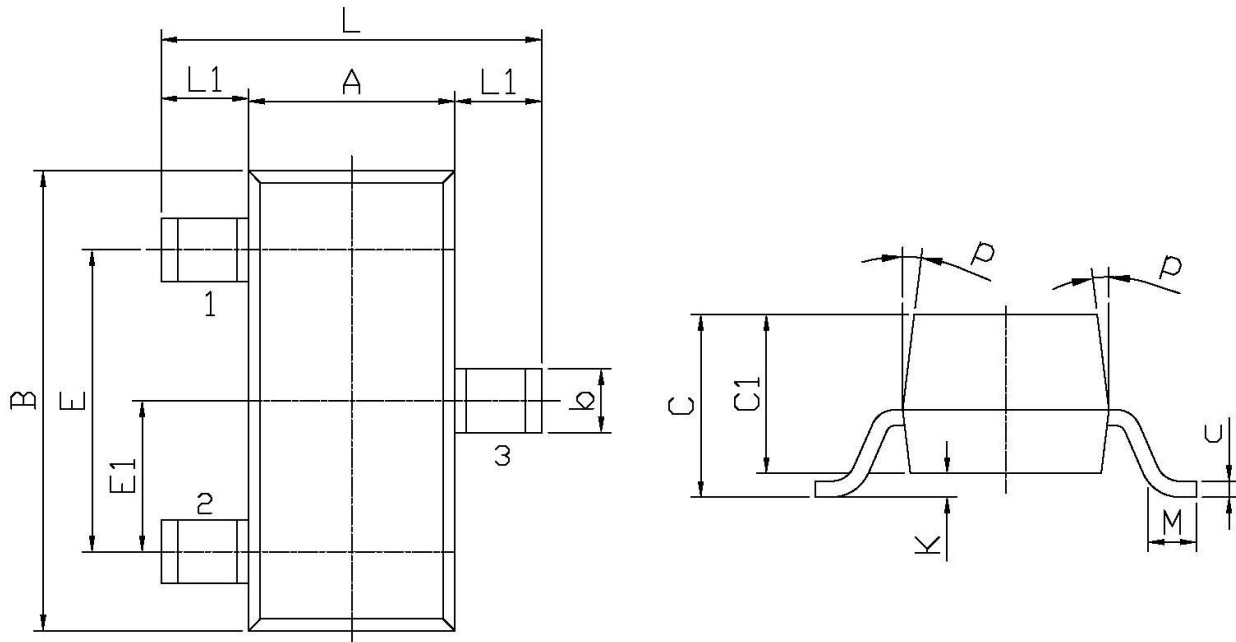

Symbol	Dimensions In Millimeters		Symbol	Dimensions In Millimeters	
	Min	Max		Min	Max
L	2.2	2.7	C	1.30Max	
L1	0.45	0.65	C1	0.90	1.20
A	1.15	1.50	c	0.05	0.20
B	2.70	3.10	K	0	0.10
E	1.70	2.10	M	0.20MIN	
E1	0.85	1.05	P	7°	
b	0.35	0.55			