

Description

Silicon NPN transistor in a SOT-23 Plastic Package

Applications

Power amplifier applications

Features

- Complementary pair with CT8550MS
- Halogen-free product

Symbol	Parameter	Max	Unit
V_{CE0}	collector-emitter voltage	25	V
I_C	collector current (DC)	800	mA

Equivalent Circuit & Pinning

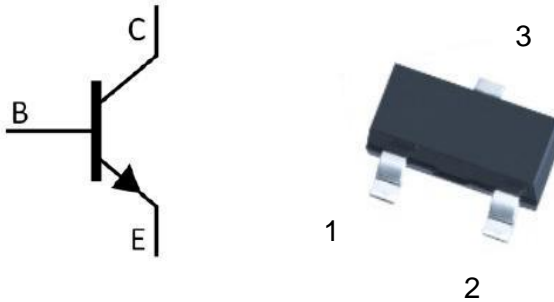

PIN1: Base

PIN 2: Emitter

PIN 3: Collector

hFE Classifications & Marking

h _{FE} Classifications Symbol	B	C	D
h _{FE} Range	85~160	120~200	160~300
Marking	HY3B	HY3C	HY3D

Absolute Maximum Ratings(Ta=25°C)

Parameter	Symbol	Rating	Unit
Collector to Base Voltage	V_{CBO}	40	V
Collector to Emitter Voltage	V_{CEO}	25	V
Emitter to Base Voltage	V_{EBO}	6.0	V
Collector Current	I_C	800	mA
Base Current	I_B	200	mA
Collector Power Dissipation	P_C	200	mW
Junction Temperature	T_j	150	°C
Storage Temperature Range	T_{stg}	-55~150	°C

Electrical Characteristics(Ta=25°C)

Parameter	Symbol	Test Conditions	Min	Typ	Max	Unit
Collector to Base Breakdown Voltage	V_{CBO}	$I_C=0.1mA$ $I_E=0$	40			V
Collector to Emitter Breakdown Voltage	V_{CEO}	$I_C=2.0mA$ $I_B=0$	25			V
Emitter to Base Breakdown Voltage	V_{EBO}	$I_E=0.1mA$ $I_C=0$	6.0			V
Collector Cut-Off Current	I_{CBO}	$V_{CB}=35V$ $I_E=0$			0.1	μA
Emitter Cut-Off Current	I_{EBO}	$V_{EB}=6.0V$ $I_C=0$			0.1	μA
DC Current Gain	$h_{FE(1)}$	$V_{CE}=1.0V$ $I_C=100mA$	85		300	
	$h_{FE(2)}$	$V_{CE}=1.0V$ $I_C=500mA$	40			
	$h_{FE(3)}$	$V_{CE}=1.0V$ $I_C=5.0mA$	45			
Collector-Emitter Saturation voltage	$V_{CE(sat)}$	$I_C=500mA$ $I_B=50mA$		0.28	0.5	V
Base-Emitter Saturation Voltage	$V_{BE(sat)}$	$I_C=500mA$ $I_B=50mA$		0.98	1.2	V
Base-Emitter Voltage	V_{BE}	$V_{CE}=1.0V$ $I_C=10mA$		0.66	1.0	V
Transition Frequency	f_T	$V_{CE}=10V$ $I_C=50mA$	100	190		MHz
Collector Output Capacitance	C_{ob}	$V_{CB}=10V$ $I_E=0$ $f=1.0MHz$		9.0		pF

Electrical Characteristic Curve

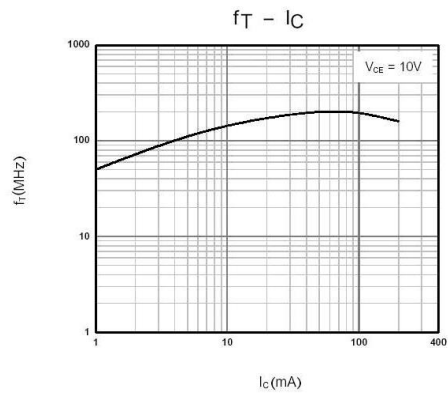
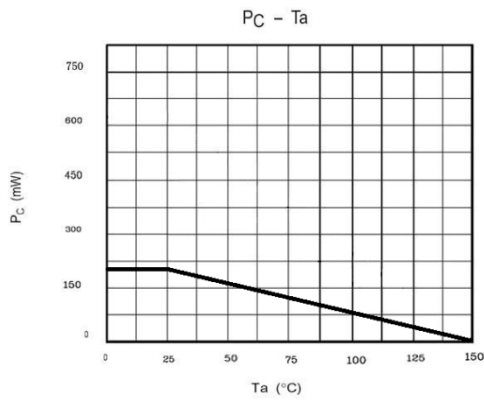
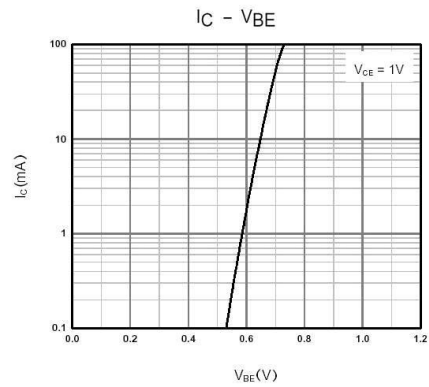
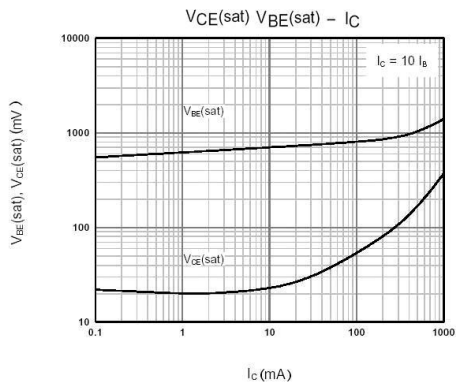
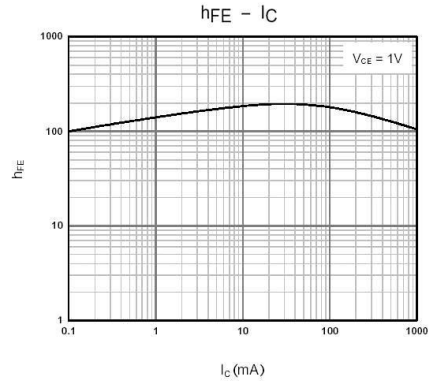
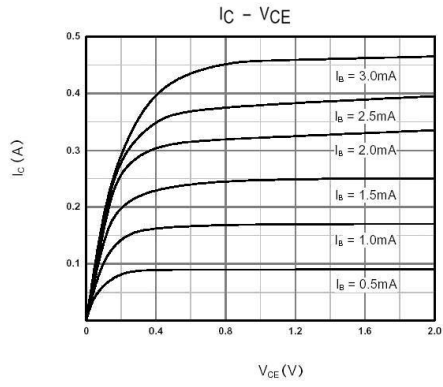

Marking Instructions

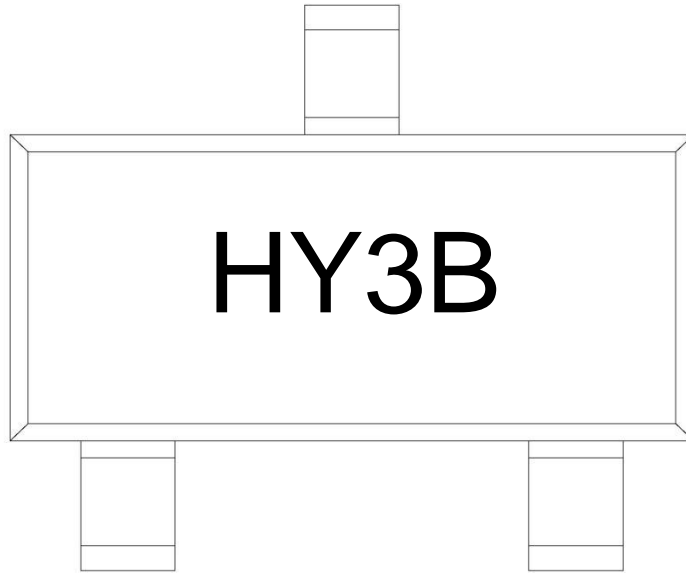

Note:

- H: Company Code
- Y3: Product Type Code
- B: h_{FE} Classifications Symbol Code

h_{FE} Classifications Symbol	B	C	D
h_{FE} Range	85~160	120~200	160~300
Marking	HY3B	HY3C	HY3D

Packaging SPEC.

REEL INFORMATION

Package Type	Units					Dimension (unit: mm ³)		
	Units/Reel	Reels/Inner Box	Units/Inner Box	Inner Boxes/Outer Box	Units/Outer Box	Reel	Inner Box	Outer Box
SOT-23	3,000	10	30,000	6	180,000	7" x8	180x120x180	390x385x205

Package Outline Dimensions

SOT-23

单位: mm

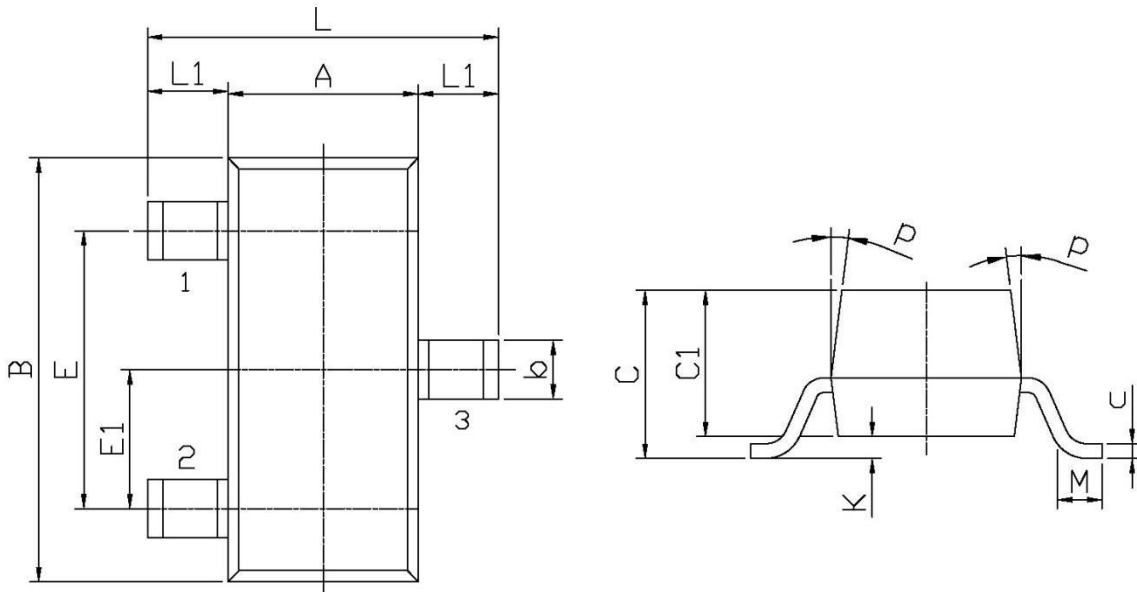

Symbol	Dimensions In Millimeters		Symbol	Dimensions In Millimeters	
	Min	Max		Min	Max
L	2.2	2.7	C	1.30Max	
L1	0.45	0.65	C1	0.90	1.20
A	1.15	1.50	c	0.05	0.20
B	2.70	3.10	K	0	0.10
E	1.70	2.10	M	0.20MIN	
E1	0.85	1.05	P	7°	
b	0.35	0.55			