

Description

Silicon NPN transistor in a SOT-23 Plastic Package

Applications

General amplifier

Features

- Low Cob
- Halogen-free Product

Symbol	Parameter	Max	Unit
V_{CE0}	collector-emitter voltage	50	V
I_C	collector current (DC)	150	mA

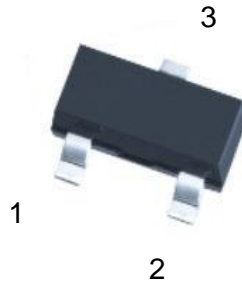
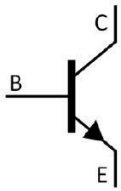
Equivalent Circuit & Pinning

PIN1: Base

PIN 2: Emitter

PIN 3: Collector

hFE Classifications & Marking

h _{FE} Classifications Symbol	Q	R	S
h _{FE} Range	120 ~ 270	180 ~ 390	270 ~ 560
Marking	HBQ	HBR	HBS

Absolute Maximum Ratings(Ta=25°C)

Parameter	Symbol	Rating	Unit
Collector to Base Voltage	V_{CBO}	60	V
Collector to Emitter Voltage	V_{CEO}	50	V
Emitter to Base Voltage	V_{EBO}	7.0	V
Collector Current	I_C	150	mA
Collector Power Dissipation	P_C	200	mW
Junction Temperature	T_j	150	°C
Storage Temperature Range	T_{stg}	-55~150	°C

Electrical Characteristics(Ta=25°C)

Parameter	Symbol	Test Conditions	Min	Typ	Max	Unit
Collector- Base Breakdown Voltage	V_{CBO}	$I_C=50\mu A$	60			V
Collector-Emitter Breakdown Voltage	V_{CEO}	$I_C=1.0mA$	50			V
Emitter-Base Breakdown Voltage	V_{EBO}	$I_E=50\mu A$	7.0			V
Collector Cut-Off Current	I_{CBO}	$V_{CB}=60V$			0.1	μA
Emitter Base Cut-Off Current	I_{EBO}	$V_{EB}=7.0V$			0.1	μA
DC Current Gain	h_{FE}	$V_{CE}=6.0V$ $I_C=1.0mA$	120		560	
Collector to Emitter Saturation Voltage	$V_{CE(sat)}$	$I_C=50mA$ $I_B=5.0mA$			0.4	V
Transition Frequency	f_T	$V_{CE}=12V$ $f=100MHz$ $I_E=-2.0mA$		180		MHz
Collector Output Capacitance	C_{ob}	$V_{CB}=12V$ $f=1.0MHz$ $I_E=0$		2.0	3.5	pF

Electrical Characteristic Curve

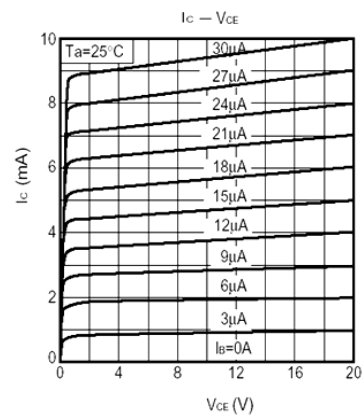
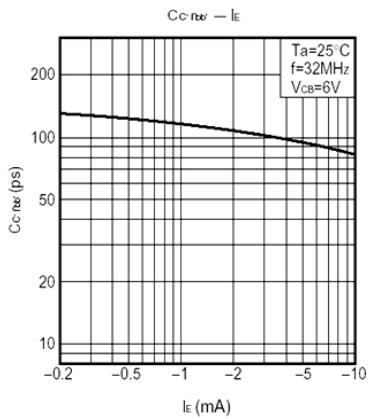
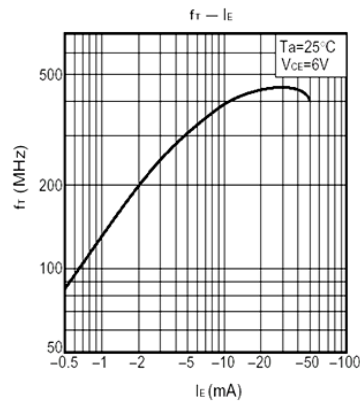
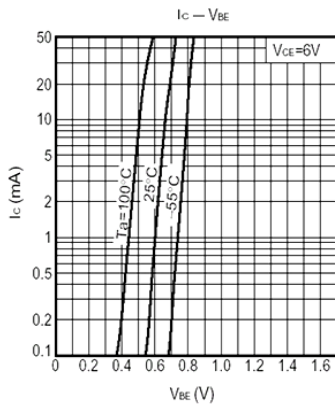
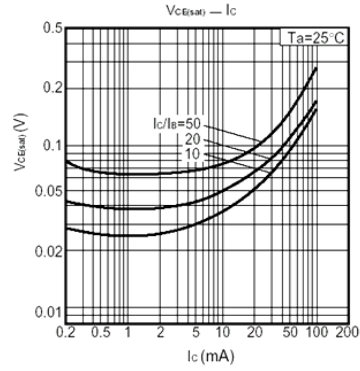
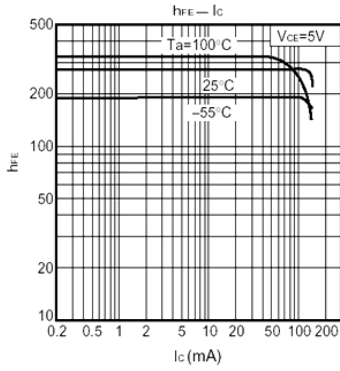

Marking Instructions

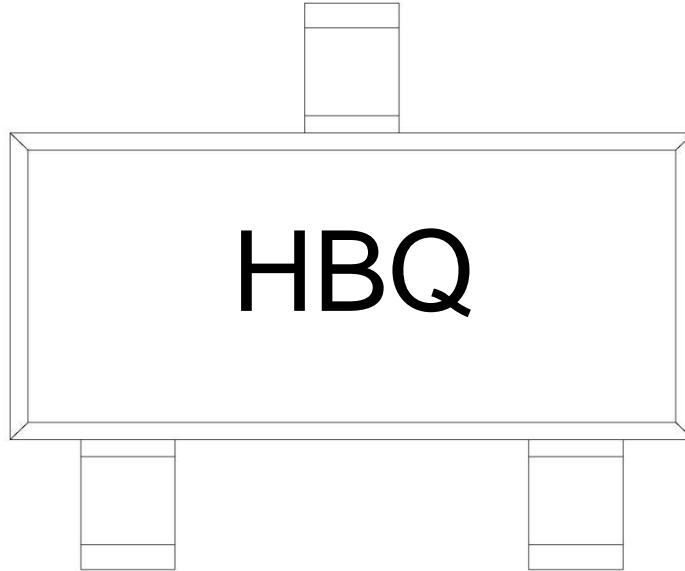

Note:

- H: Company Code
- B: Product Type Code
- S: h_{FE} Classifications Symbol

h_{FE} Classifications Symbol	Q	R	S
h_{FE} Range	120 ~ 270	180 ~ 390	270 ~ 560
Marking	HBQ	HBR	HBS

Packaging SPEC.

REEL INFORMATION

Package Type	Units					Dimension (unit: mm ³)		
	Units/Reel	Reels/Inner Box	Units/Inner Box	Inner Boxes/Outer Box	Units/Outer Box	Reel	Inner Box	Outer Box
SOT-23	3,000	10	30,000	6	180,000	7" x8	180x120x180	390x385x205

Package Outline Dimensions

SOT-23

单位: mm

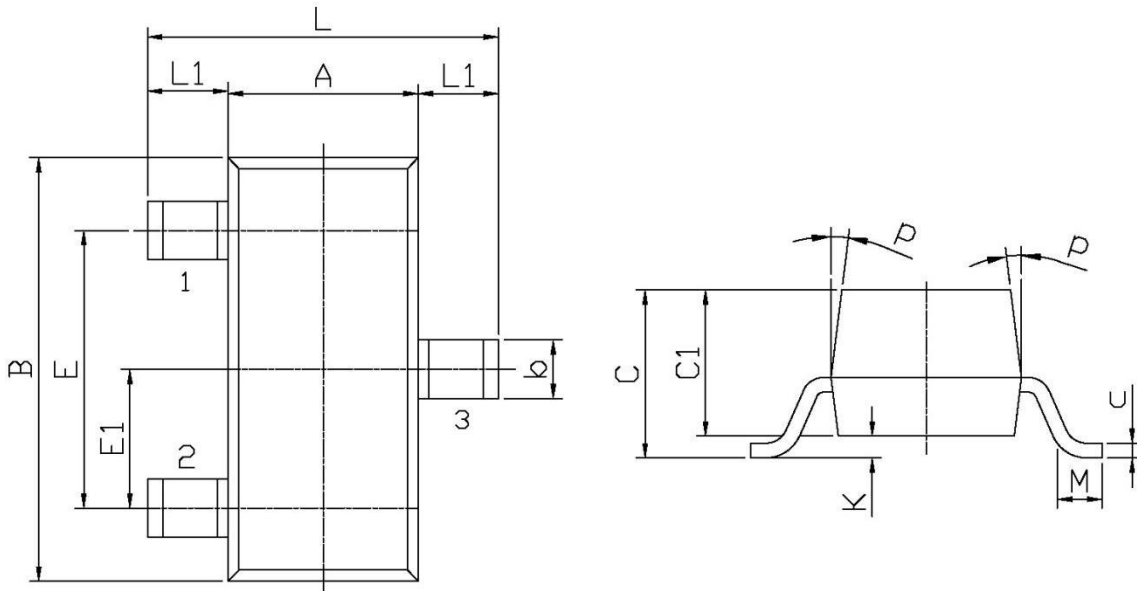

Symbol	Dimensions In Millimeters		Symbol	Dimensions In Millimeters	
	Min	Max		Min	Max
L	2.2	2.7	C	1.30Max	
L1	0.45	0.65	C1	0.90	1.20
A	1.15	1.50	c	0.05	0.20
B	2.70	3.10	K	0	0.10
E	1.70	2.10	M	0.20MIN	
E1	0.85	1.05	P	7°	
b	0.35	0.55			