

Descriptions

This is N-Ch SiC Power MOSFET in a TO-247-4 Plastic Package.

Features

- VDS=1200V
- ID=60A (Tc=25°C)
- RDS=32mΩ (VGS=18V,TJ=25°C)
- Low On-Resistance with High Blocking Voltage
- High Speed Switching with Low Capacitance
- Avalanche Ruggedness
- Halogen Free, Rohs Compliant

Applications

- Switch Mode Power Supplies (SMPS)
- Pulsed Power applications
- Motor Drivers & Battery Chargers
- High Voltage DC/DC Converter

Benefits

- High Switching Frequency Operation
- High System Efficiency
- Increased Power Density
- Reduction of Heat Sink Requirements

Schematic & PIN Configuration

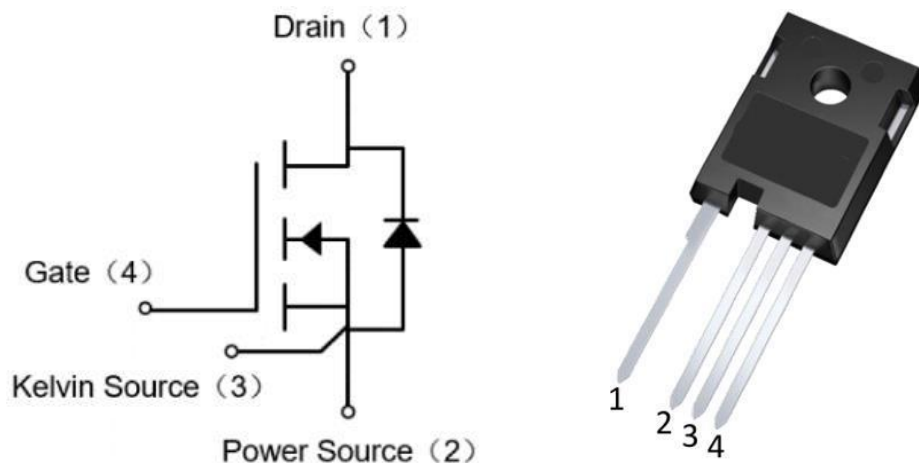

Maximum Rated Valued of MOSFET

Drain-source voltage	V_{DSS}		1200	V
Recommend Gate-Source Voltage	V_{GSop}		-5/18	V
Gate-Source Voltage	V_{GSmax}		-8/20	V
Continuous drain current	I_D	$T_C=100^{\circ}C, V_{GS}=20V$	40	A
		$T_C=25^{\circ}C, V_{GS}=20V$	60	
Pulsed drain current	I_{DM}	t_{Pulse} limited by T_{Jmax}	100	A
Maximum power dissipation	P_{tot}	$T_C=25^{\circ}C, T_J=175^{\circ}C$	312	W
Operating Junction Temperature	T_J		-55~175	$^{\circ}C$
Storage Temperature	T_{stg}		-55~175	$^{\circ}C$

Thermal Characteristic

Thermal resistance, junction-to-case	$R_{\theta JC}$		0.48	$^{\circ}C/W$
Thermal resistance, junction-to-ambient	$R_{\theta JA}$		42	$^{\circ}C/W$

Electrical Characteristics of MOSFET

Drain-Source breakdown voltage	$V_{(BR)DS}$	$I_D=100\mu A, V_{GS}=0V$	$T_J=25^\circ C$	1200	-	-	V
Gate threshold voltage	$V_{GS(th)}$	$I_D=10mA, V_{DS}=V_{GS}$	$T_J=25^\circ C$	2.0	3.2	4.0	V
Zero gate voltage drain current	I_{DSS}	$V_{DS}=1200V, V_{GS}=0V$	$T_J=25^\circ C$	-	1	100	μA
Gate-Source leakage current	I_{GSS}	$V_{DS}=0V, V_{GS}=20V$	$T_J=25^\circ C$	-	-	200	nA
Drain-Source On-State resistance	$R_{DS(ON)}$	$V_{GS}=18V, I_D=33A$	$T_J=25^\circ C$	-	32	50	$m\Omega$
			$T_J=150^\circ C$	-	47	-	$m\Omega$
Transconductance	g_{fs}	$V_{DS}=20V, I_D=33A$	$T_J=25^\circ C$	-	20	-	S
Internal gate resistor	R_{Gint}	$f=1MHz, V_{AC}=30mV$	$T_J=25^\circ C$	-	1.9	-	Ω
Input capacitance	C_{iss}	$f=1MHz, V_{DS}=1000V, V_{AC}=30mV, V_{GS}=0V$	$T_J=25^\circ C$	-	3400	-	pF
Output capacitance	C_{oss}			-	133	-	pF
Reverse transfer capacitance	C_{rss}			-	18.0	-	pF
Gate to source charge	Q_{GS}	$V_{DS}=800V$	$T_J=25^\circ C$	-	40	-	nC
Gate to drain charge	Q_{GD}	$I_{DS}=33A$		-	37	-	nC
Total gate charge	Q_G	$V_{GS}=-5V/18V$		-	128	-	nC
Turn-on delay time	$t_{d on}$	$V_{DS}=800V, I_{DS}=33A, R_{G-ext}=5\Omega, V_{GS}=-5V/18V,$	$T_J=25^\circ C$	-	60	-	ns
Rise time	t_r		$T_J=25^\circ C$	-	140	-	ns
Turn-off delay time	$t_{d off}$		$T_J=25^\circ C$	-	50	-	ns
Fall time	t_f		$T_J=25^\circ C$	-	42	-	ns
Turn-on energy loss per pulse	E_{on}		$T_J=150^\circ C$	-	1100	-	μJ
Turn-off energy loss per pulse	E_{off}		$T_J=150^\circ C$	-	410	-	μJ

Characteristics of Body Diode

Forward voltage	V_{SD}	$I_{SD}=20A, V_{GS}=-5V$	$T_J=25^\circ C$	-	3.6	-	V
Continuous diode forward current	I_S	$V_{GS}=0V$	$T_J=25^\circ C$	-	60	-	A
Peak reverse recovery current	I_{RM}	$V_{DS}=800V, I_{SD}=33A, V_{GS}=-5V, -di/dt=1200A/\mu s$	$T_J=150^\circ C$	-	15	-	A
Reverse recovery time	t_{rr}		$T_J=150^\circ C$	-	35	-	ns
Recovery charge	Q_{rr}		$T_J=150^\circ C$	-	165	-	nC

Typical Characteristics

Fig.1 Typical Forward Output Characteristics at $T_J=25^\circ\text{C}$

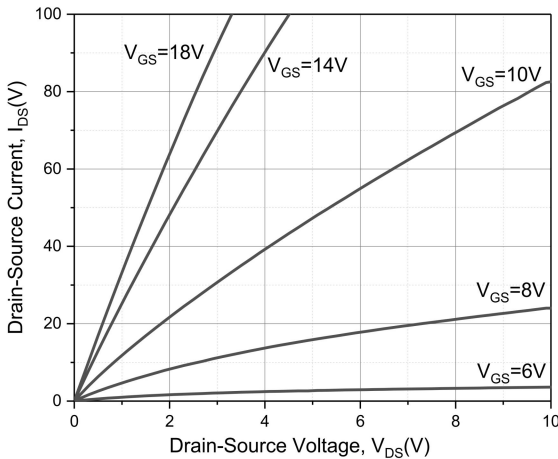

Fig.2 Typical Forward Output Characteristics at $T_J=150^\circ\text{C}$

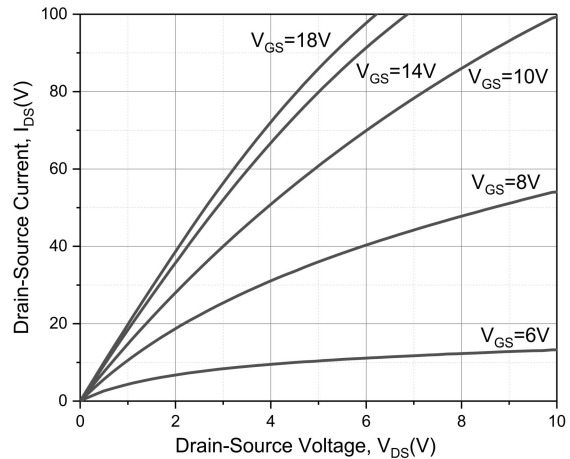

Fig.3 On-Resistance For Various Gate Voltage

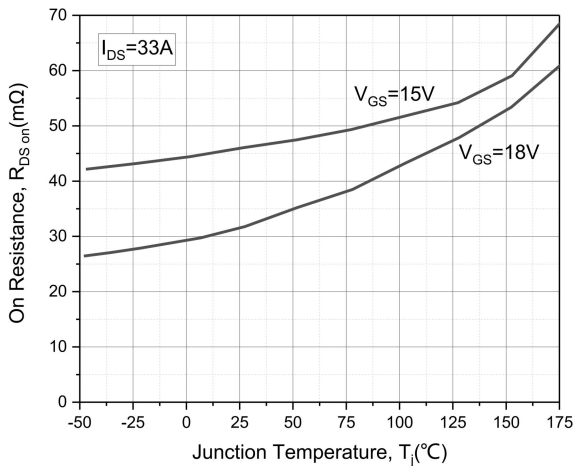

Fig.4 Transfer Characteristic for Various Junction Temperatures

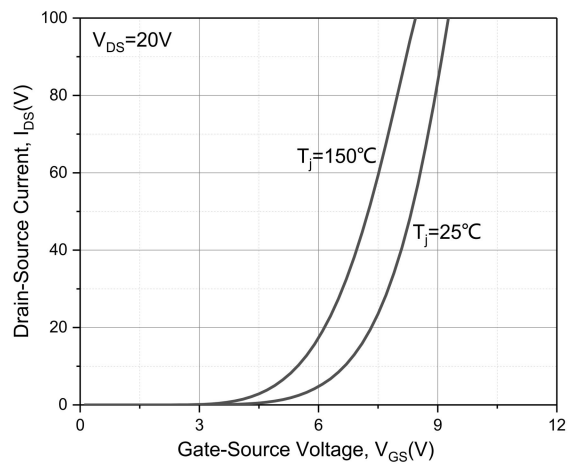

Fig.5 Threshold Voltage vs. Temperature

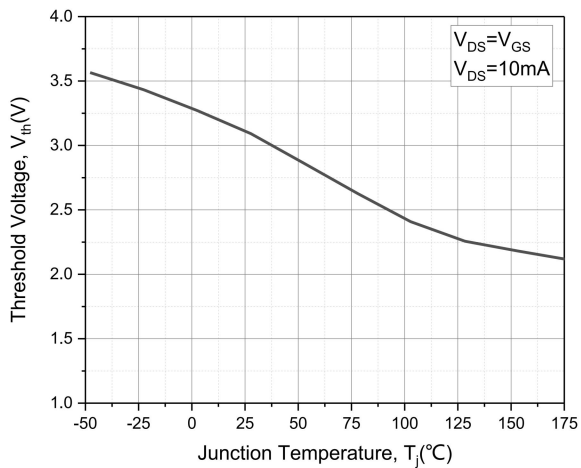
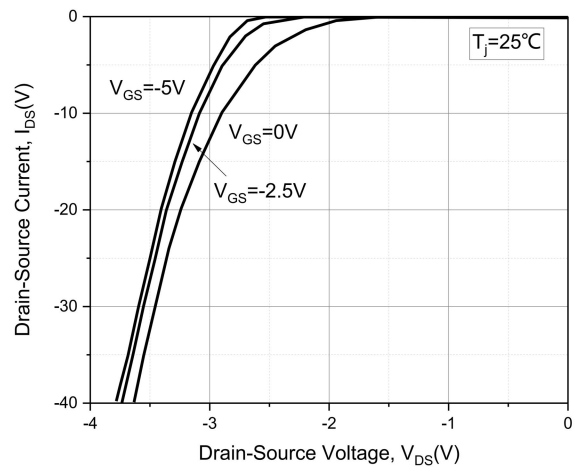

Fig.6 Body Diode Characteristics at $T_J=25^\circ\text{C}$



Typical Characteristics

Fig.7 Body Diode Characteristics at $T_J = 150^\circ\text{C}$

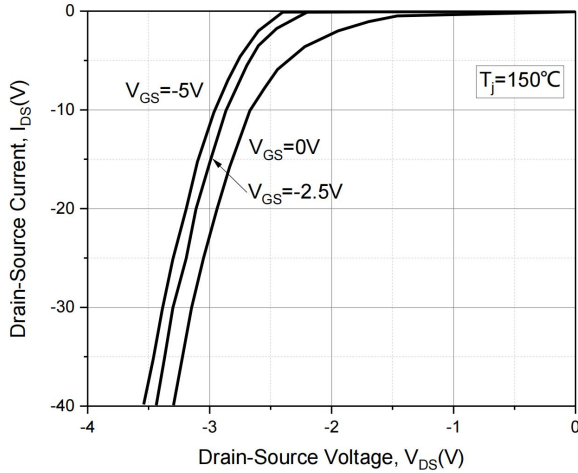

Fig.8 Capacitance vs. Drain-Source Voltage (0 - 1200V)

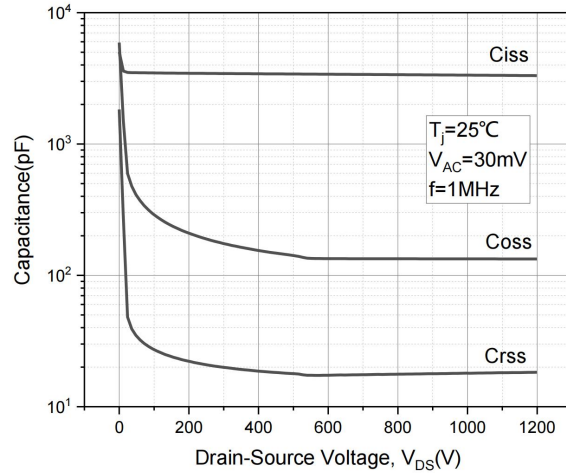

Fig.9 Gate Charge Characteristics

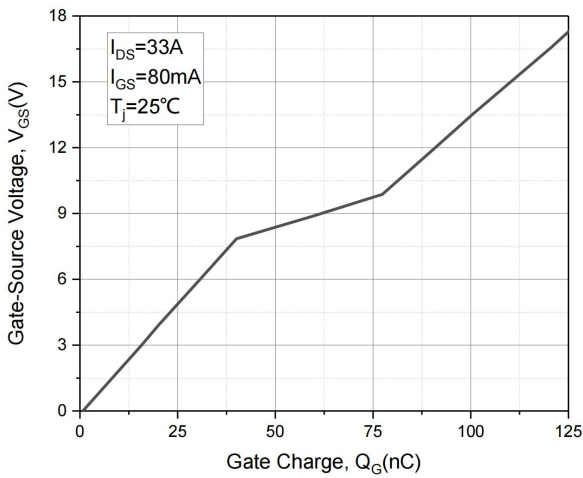

Fig.10 Maximum Power Dissipation Derating vs. Case Temperature

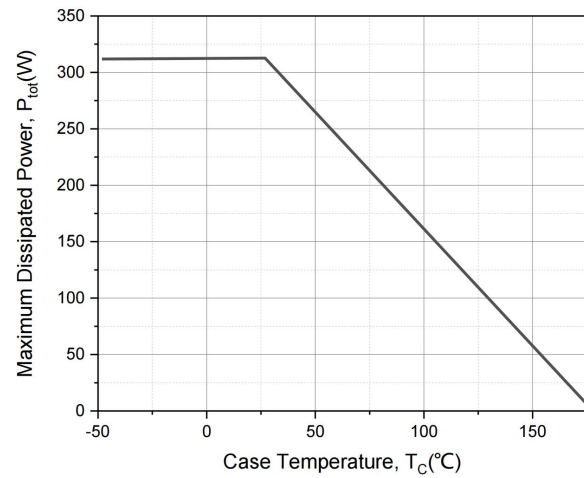
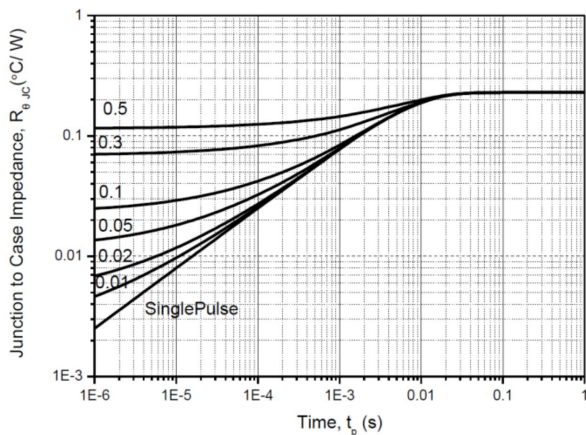

Fig.11 Transient Thermal Impedance (Junction – Case)



Ordering Information

Part	Package	Marking	Packing method
CTCM032R120T2C	TO-247-4	32R120T2C	Tube

Package Information

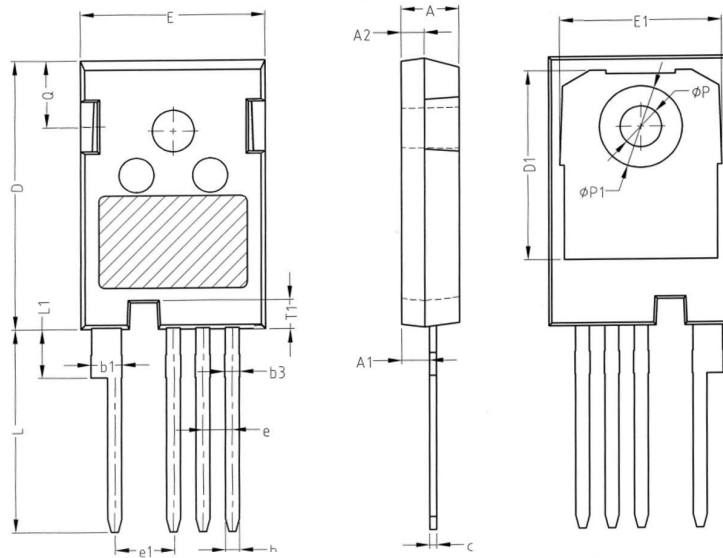

SYMBOL	MM		
	MIN	NOM	MAX
A	4.80	5.00	5.20
A1	2.21	2.41	2.61
A2	1.80	2.00	2.20
b	1.06	1.21	1.36
b1	2.33	2.63	2.93
b3	1.07	1.30	1.60
c	0.51	0.61	0.75
D	23.30	23.45	23.60
D1	16.25	16.55	16.85
E	15.74	15.94	16.14
E1	13.72	14.02	14.32
T1	2.35	2.50	2.65
e	2.54 BSC		
e1	5.08 BSC		
Q	5.49	5.79	6.09
L	17.27	17.57	17.87
L1	3.99	4.19	4.39
Φp	3.40	3.60	3.80
Φp1	7.19 REF		