

## Descriptions

This is 1200V 40A Trench FS Technology IGBT in a TO-247 Plastic Package.

## Features

- Field Stop Trench Technology , Positive temperature coefficient
- $V_{CE(sat)}=2.2V@I_C=40A$
- High Speed Switching & Low Power Loss
- High Input Impedance

## Applications

- PFC (Power Factor Correction)
- UPS (Uninterruptible Power Supply)
- Welder
- PV Inverter
- Solar Inverter

## Equivalent Circuit & Pinning

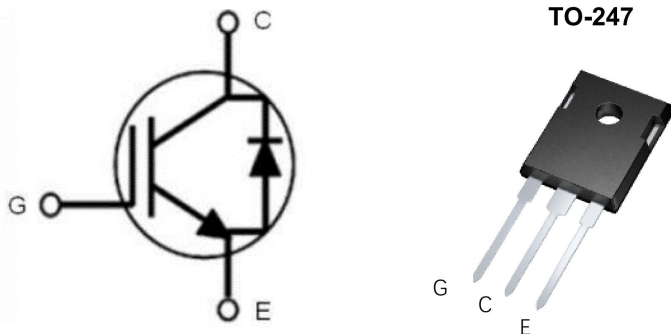

## Marking

See Marking Instructions

**Maximum Ratings**

Parameter	Symbol	Test Condition	Values	Unit
Collector to Emitter Voltage	$V_{CES}$		1200	V
Gate to Emitter Voltage	$V_{GES}$		$\pm 20$	V
Collector Current	$I_C$	$T_C=25^{\circ}C$	80	A
Pulsed Collector Current	$I_{CM}$	$T_C=100^{\circ}C$	40	A
Pulsed Collector Current	$I_{CM}$		160	A
Diode Continuous Forward Current	$I_F$	$T_C=100^{\circ}C$	20	A
Diode Maximum Forward Current	$I_{FM}$		100	A
Maximum Power Dissipation	$P_D$	$T_C=25^{\circ}C$	312	W
Storage Temperature Range	$T_{STG}$	$T_C=100^{\circ}C$	156	$^{\circ}C$
Operating Junction Temperature Range	$T_J$		-50~+150	$^{\circ}C$
Storage Temperature Range	$T_{STG}$		-50~+150	$^{\circ}C$
Thermal Resistance, Junction to case for IGBT	$R_{th(J-C)}$		0.4	$^{\circ}C/W$
Thermal Resistance, Junction to case for Diode	$R_{th(J-C)}$		1.2	$^{\circ}C/W$
Thermal Resistance, Junction to Ambient	$R_{th(J-A)}$		40	$^{\circ}C/W$

### Electrical Characteristics of IGBT

Parameter	Symbol	Test Condition		Min.	Typ.	Max.	Unit
Collector to Emitter Breakdown Voltage	$BV_{CES}$	$I_C=1mA, V_{GE}=0V$	$T_C=25^\circ C$	1200	-	-	V
Collector to Emitter Saturation Voltage	$V_{CE(sat)}$	$I_C=40A, V_{GE}=15V$	$T_C=25^\circ C$	-	2.2	2.7	V
		$I_C=40A, V_{GE}=15V$	$T_C=125^\circ C$	-	2.5	-	
Gate Threshold Voltage	$V_{GE(th)}$	$I_C=250\mu A, V_{CE}=V_{GE}$	$T_C=25^\circ C$	4.8	6.4	8.0	V
Zero Gate Voltage Collector current	$I_{CES}$	$V_{CE}=V_{CES}, V_{GS}=0V$	$T_C=25^\circ C$	-	-	500	$\mu A$
Gate to Emitter Leakage Current	$I_{GES}$	$V_{GE}=V_{GES}, V_{CE}=0V$	$T_C=25^\circ C$	-	-	$\pm 400$	nA
Input Capacitance	$C_{ies}$	$f=1MHz, V_{CE}=30V, V_{GE}=0V$	$T_C=25^\circ C$	-	4404	-	pF
Output Capacitance	$C_{oes}$			-	140	-	pF
Reverse Transfer Capacitance	$C_{res}$			-	30	-	pF
Gate charge	$Q_G$	$V_{CC}=600V, I_C=40A, V_{GS}=-\dots+15V$	$T_C=25^\circ C$	-	134	-	nC
Short Circuit Withstand Time	$t_{sc}$	$V_{CC}=600V, V_{GE}=15V$	$T_C=25^\circ C$	5	-	-	us
Turn-on Delay Time	$t_{d(on)}$	$V_{CC}=600V, I_C=40A, V_{GE}=15V, R_G=10\Omega$	$T_C=25^\circ C$	-	44	-	ns
Rising Time	$t_r$		$T_C=25^\circ C$	-	118	-	ns
Turn-off Delay Time	$t_{d(off)}$		$T_C=25^\circ C$	-	102	-	ns
Falling Time	$t_f$		$T_C=25^\circ C$	-	84	-	ns
Turn-on Switching Loss	$E_{on}$		$T_C=25^\circ C$	-	3.9	-	mJ
Turn-off Switching Loss	$E_{off}$		$T_C=25^\circ C$	-	0.6	-	mJ

### Electrical Characteristics of Diode

Parameter	Symbol	Test Condition		Min.	Typ.	Max.	Unit
Diode Forward Voltage	$V_F$	$I_F=20A$	$T_C=25^\circ C$	-	2.4	3.1	V
		$I_F=20A$	$T_C=125^\circ C$	-	1.9	-	V
Diode Peak Reverse Recovery Current	$I_{rr}$	$V_{CC}=200V, I_F=20A, -dif/dt=100A/us$	$T_C=25^\circ C$	-	2.8	-	A
Diode Reverse Recovery Time	$t_{rr}$		$T_C=25^\circ C$	-	62	-	ns
Diode Reverse Recovery Charge	$Q_{rr}$		$T_C=25^\circ C$	-	90	-	$\mu C$

Typical Performance

Fig.1 Typical Output Characteristics at 25°C

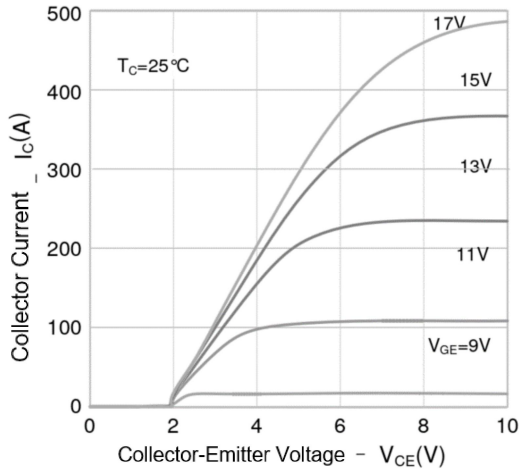

Fig.2 Typical Saturation Pressure Drop Characteristics

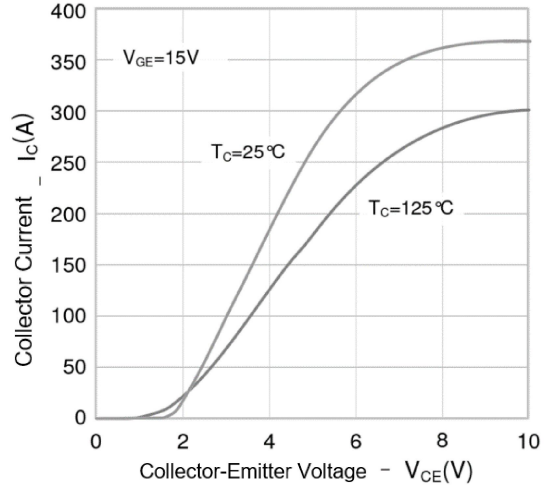

Fig.3 Transmission Characteristic Curve

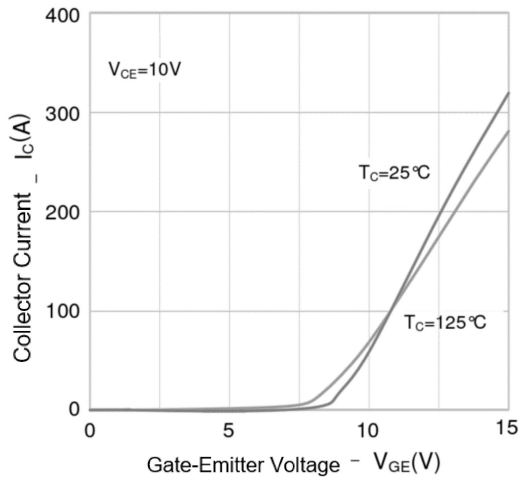

Fig.4 Saturation Voltage vs. VGE

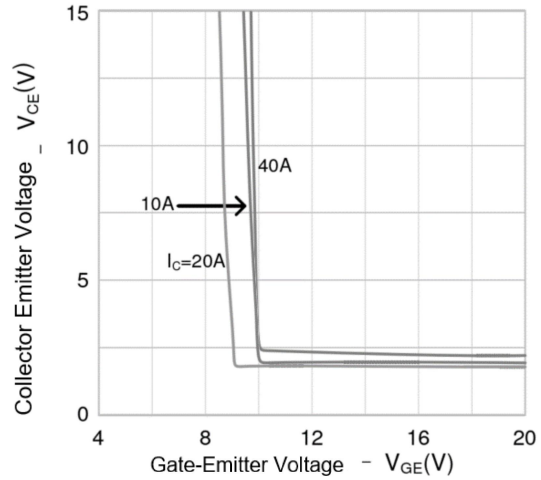

Fig.5 Saturation Voltage vs. VGE

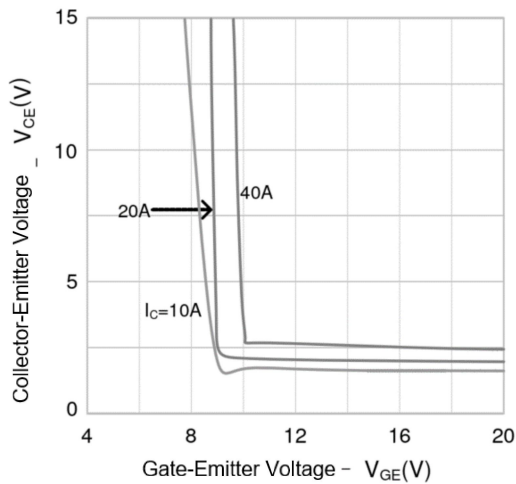
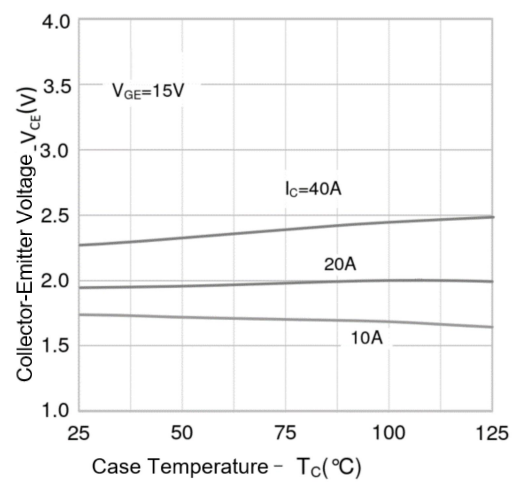

Fig.6 Saturation Voltage vs. Temperature



Typical Performance

Fig.7 Capacitance Characteristic

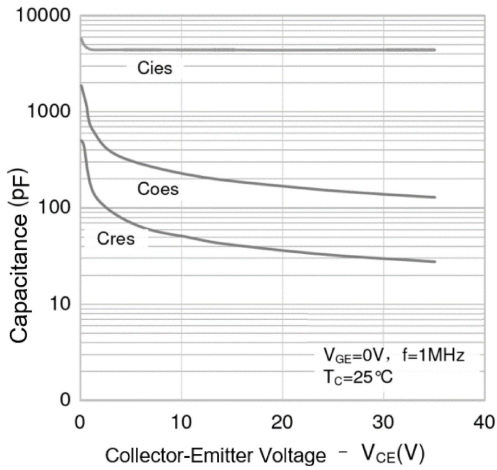

Fig.8 Gate Charge Characteristics

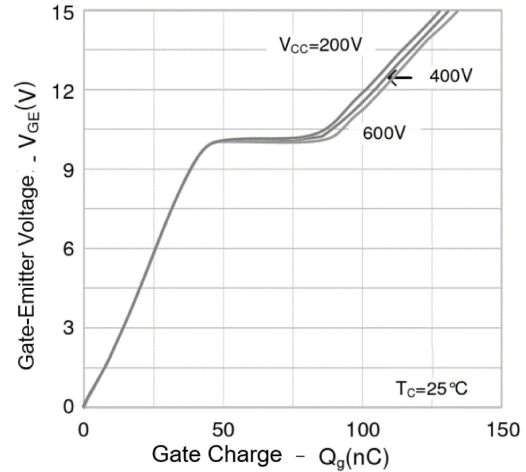

Fig.9 Conduction Characteristics vs. Gate Resistance

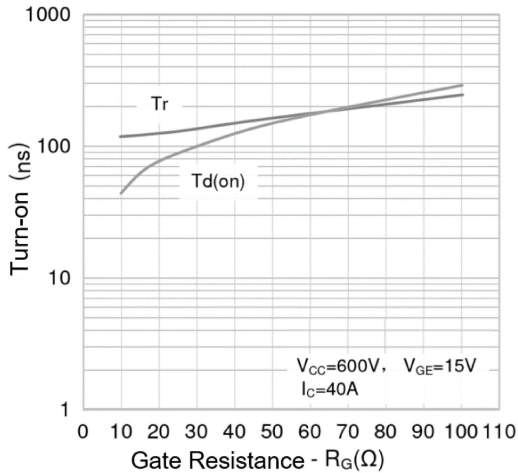

Fig.10 Turn Off Characteristic vs. Gate Resistance

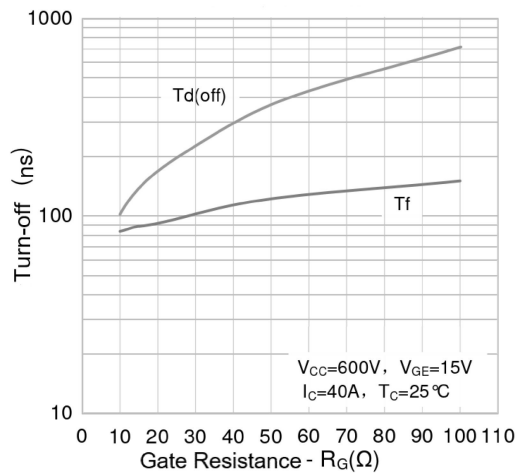

Fig.11 Switch Loss vs. Gate Resistance

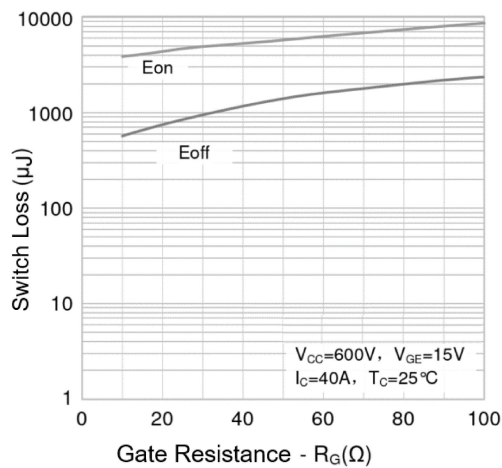
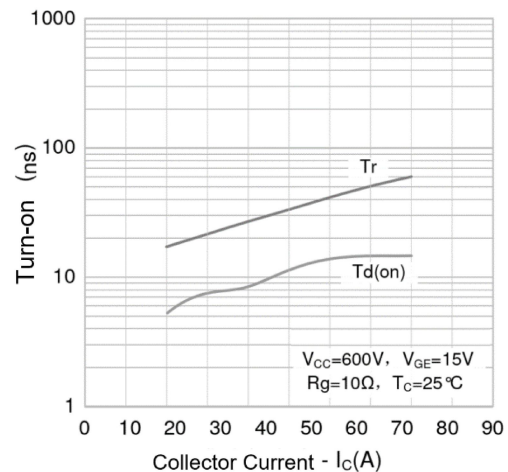

Fig.12 Conduction Characteristics vs. Collector Current



Typical Performance

Fig.13 Turn Off Characteristic vs. Collector Current

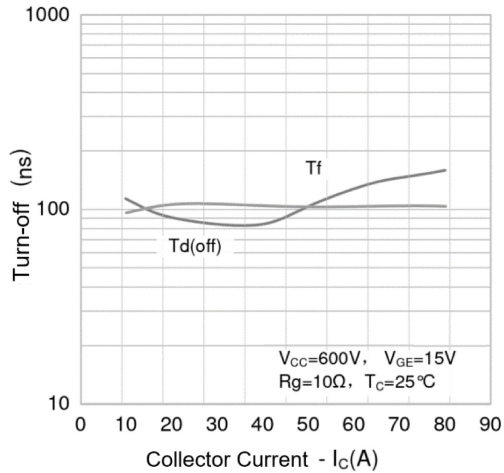

Fig.14 Switching Loss vs. Collector Current

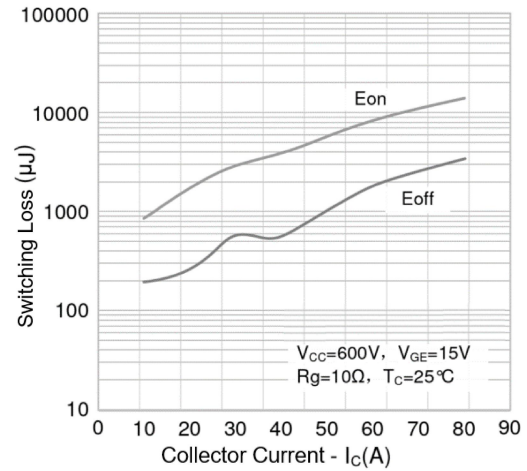

Fig.15 Forward Characteristic

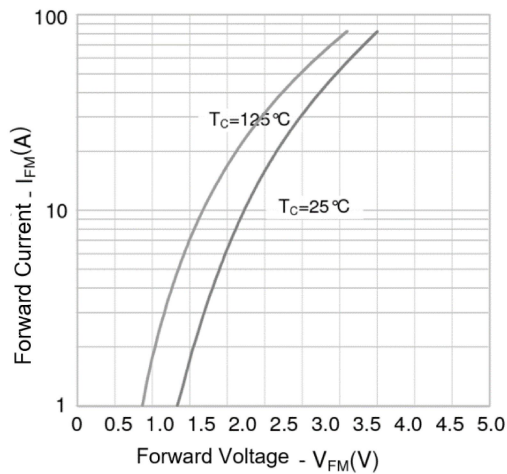

Fig.16 Reverse Recovery time vs. Forward Current

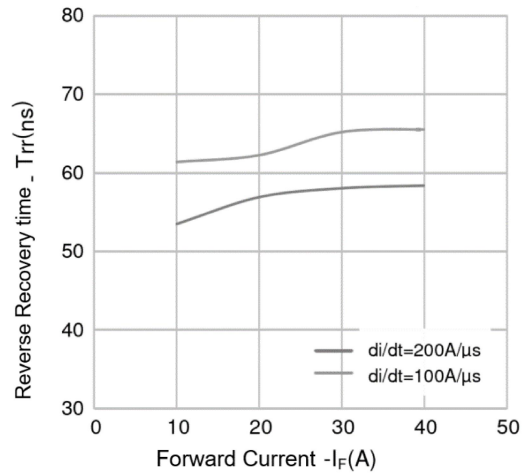

Fig.17 Reverse Recovery Charge vs. Forward Current

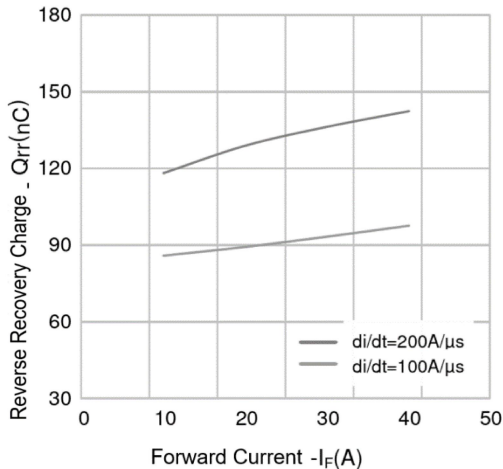
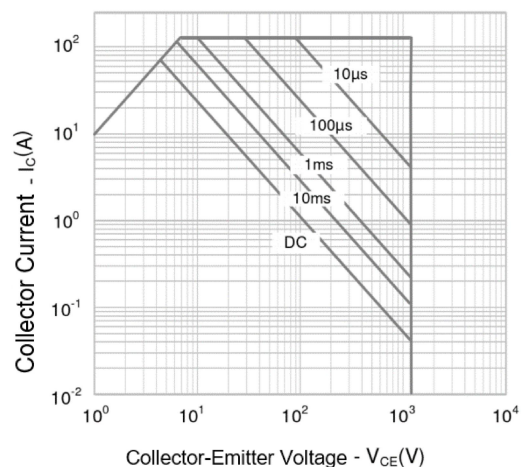

Fig.18 Maximum Safe Work Area Collector Current



Typical Performance

Fig.19 Peak Reverse Recovery Current vs. Forward Current

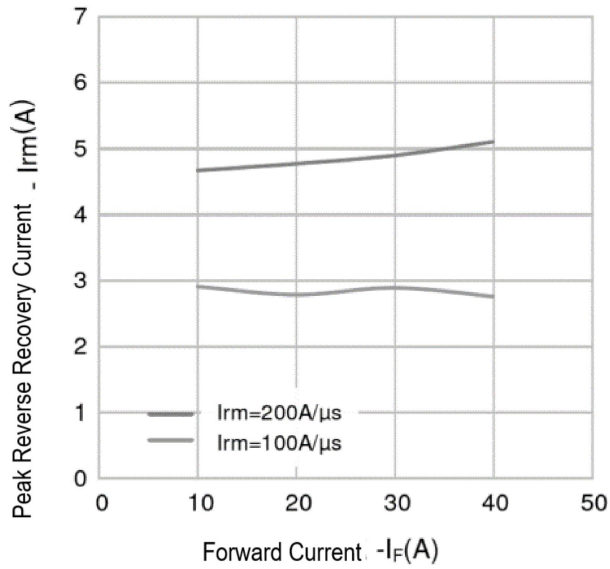
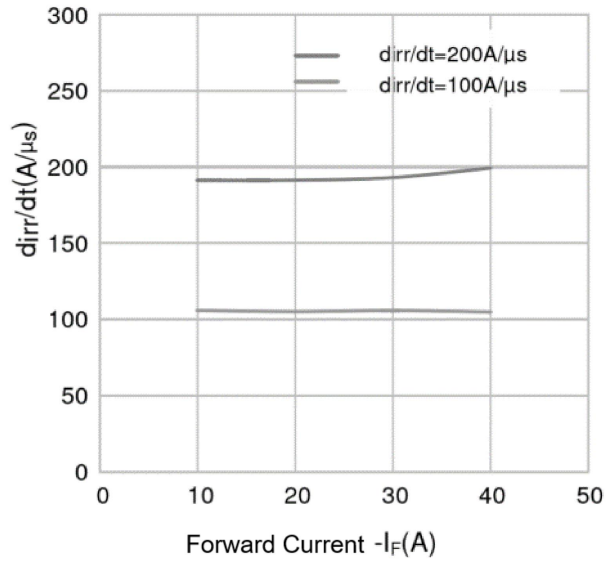

Fig.20 Slope vs. Forward Current



**Marking Information**



Note:

COT: Company

GB40N120: Product Type.

\*\*\*\*\*: \*: Inner Code \* : Year Code \*\*: Week Code \*\*: Lot Code

**Ordering Information**

Part	Package	Marking	Packing method
CTGB40N120	TO-247-3	40N120	Tube



**Mechanical Dimensions for TO-247**

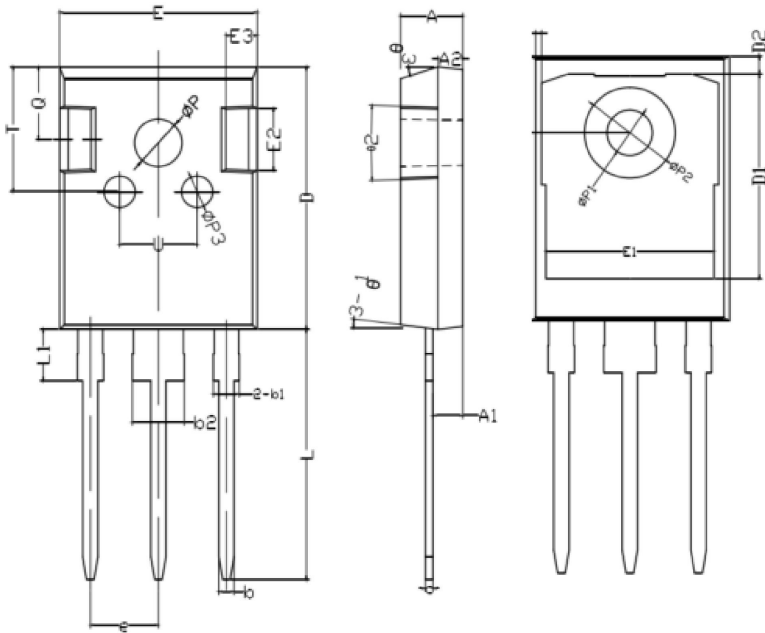

**COMMON DIMENSIONS**

SYMBOL	MM	
	MIN	MAX
A	4.80	5.20
A1	2.21	2.59
A2	1.85	2.15
b	1.11	1.36
b1	1.91	2.25
b2	2.91	3.25
c	0.51	0.75
D	20.70	21.30
D1	16.25	16.85
E	15.50	16.10
E1	13.00	13.60
E2	4.80	5.20
E3	2.30	2.70
e	5.40	5.48
L	19.62	20.22
L1	-	4.30
ØP	3.40	3.80
ØP2	6.90	7.30
S	6.05	6.25