

Descriptions

This is N-Ch SiC Power MOSFET in a TO-263-7L Plastic Package.

Features

- VDS=1700V
- ID=5A (Tc=25°C)
- RDS=710mΩ (VGS=15V,TJ=25°C)
- Low On-Resistance with High Blocking Voltage
- Low Capacitance
- Halogen Free, Rohs Compliant

Applications

- Switch Mode Power Supplies (SMPS)
- Auxiliary power supplies
- High-voltage capacitive loads

Benefits

- High Frequency Operation
- Enabling Higher Switching Frequency
- Increased Power Density
- Reduction of Heat Sink Requirements

Schematic & PIN Configuration

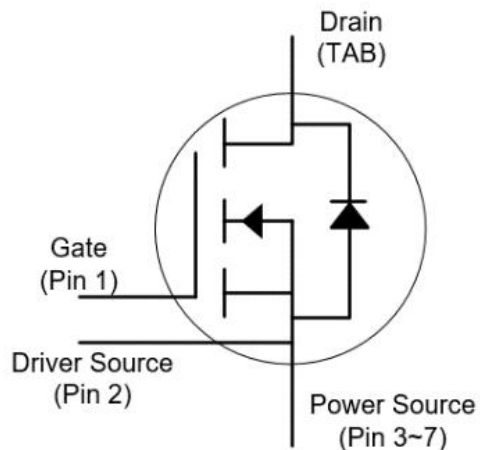

Maximum Rated Valued of MOSFET

Drain-source voltage	V_{DSS}		1700	V
Recommend Gate-Source Voltage	V_{GSop}		-5/12...15	V
Gate-Source Voltage	V_{GSmax}	AC(f > 1KHz)	-10/25	V
Continuous drain current	I_D	$V_{GS}=15V, T_C=100^{\circ}C$	3.5	A
		$V_{GS}=15V, T_C=25^{\circ}C$	5	A
Pulsed drain current	I_{DM}	t_{Pulse} limited by T_{jmax}	12	A
Maximum power dissipation	P_{tot}	$T_C=25^{\circ}C, T_J=150^{\circ}C$	70	W
Operating Junction Temperature	T_J		-55~150	$^{\circ}C$
Storage Temperature	T_{stg}		-55~150	$^{\circ}C$

Thermal Characteristic

Thermal resistance, junction-to-case	$R_{\theta JC}$		1.78	$^{\circ}C/W$
Thermal resistance, junction-to-ambient	$R_{\theta JA}$		62.5	$^{\circ}C/W$

Electrical Characteristics of MOSFET

Drain-Source breakdown voltage	V(BR) _{DS}	ID=250uA, VGS=0V	TJ=25°C	1700	-	-	V
Gate threshold voltage	VGS(th)	ID=5mA, VDS=VGS	TJ=25°C TJ=150°C	2.0 -	2.9 2.0	4.0 -	V
Zero gate voltage drain current	IDSS	VDS=1700V, VGS=0V	TJ=25°C	-	-	100	uA
Gate-Source leakage current	IGSSF	VDS=0V, VGS=20V	TJ=25°C	-	-	200	nA
	IGSSR	VDS=0V, VGS=-4V	TJ=25°C	-	-	-200	nA
Drain-Source On-State resistance	RDS(ON)	VGS=15V, ID=2A	TJ=25°C	-	710	850	mΩ
			TJ=150°C	-	1010	-	mΩ
		VGS=12V, ID=2A	TJ=25°C	-	1040	1200	mΩ
			TJ=150°C	-	1230	-	mΩ
Transconductance	gfs	VDS=20V, ID=2A	TJ=25°C	-	7.3	-	S
Internal gate resistance	RGint	f=1MHz, VAC=25mV	TJ=25°C	-	20	-	Ω
Input capacitance	Ciss	f=1MHz, VDS=1000V, VGS=0V, VAC=25mV	TJ=25°C	-	380	-	pF
Output capacitance	Coss		TJ=25°C	-	14	-	pF
Reverse transfer capacitance	Crss		TJ=25°C	-	3.2	-	pF
Gate to source charge	QGS		VDS=800V	TJ=25°C	-	4.8	-
Gate to drain charge	QGD	IDS=2A	TJ=25°C	-	5.6	-	nC
Total gate charge	QG	VGS= -5V/20V	TJ=25°C	-	13	-	nC
Turn-on delay time	td on	VDS=1200V, IDS=2A, RG-ext=2.5Ω, VGS=-5V/20V,	TJ=25°C	-	6	-	ns
Rise time	tr		TJ=25°C	-	9.5	-	ns
Turn-off delay time	td off		TJ=25°C	-	14	-	ns
Fall time	tf		TJ=25°C	-	23	-	ns
Turn-on energy loss per pulse	Eon		TJ=25°C	-	37	-	uJ
Turn-off energy loss per pulse	Eoff		TJ=25°C	-	15	-	uJ

Characteristics of Body Diode

Forward voltage	VSD	ISD=1A, VGS=-4V	TJ=25°C	-	3.5	-	V
Continuous diode forward current	IS		TJ=25°C	-	-	4	A
Peak reverse recovery current	IRM	VR=1200V, ISD=2A,	TJ=150°C	-	3.5	-	A
Reverse recovery time	trr	VGS=-5V	TJ=150°C	-	22	-	ns
Recovery charge	Qrr	-di/dt=1200A/us	TJ=150°C	-	31	-	nC

Typical Characteristics

Fig.1 Typical Forward Output Characteristics at $T_J=25^\circ\text{C}$

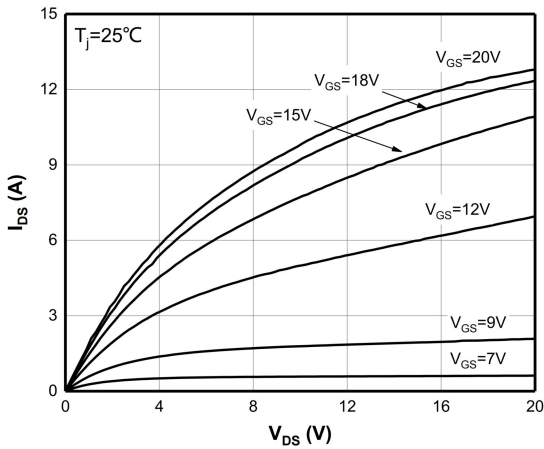

Fig.2 Typical Forward Output Characteristics at $T_J=150^\circ\text{C}$

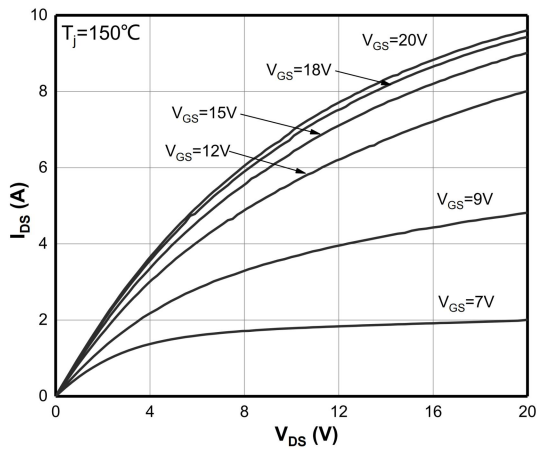

Fig.3 Transfer Characteristics for Various Temperature

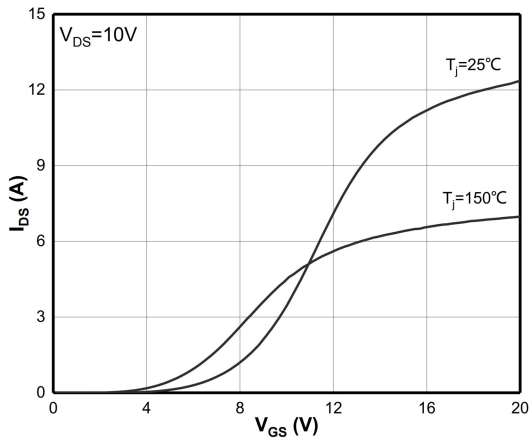

Fig.4 Threshold Voltage for Various Temperature

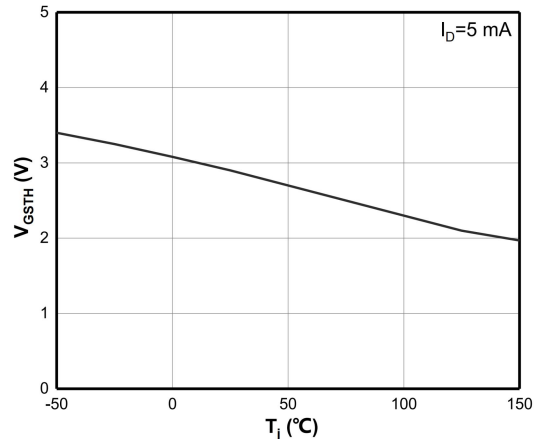

Fig.5 Normalized On-Resistance vs. Temperature for Various Gate Voltage

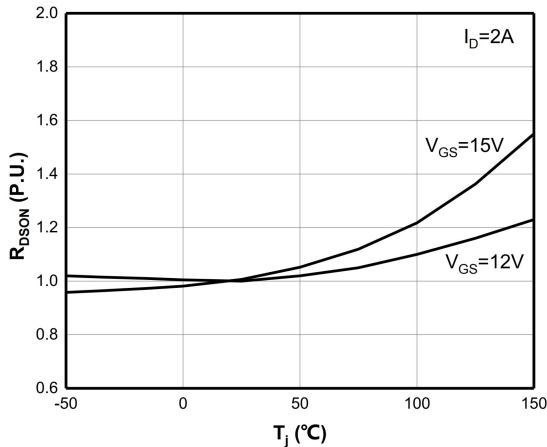
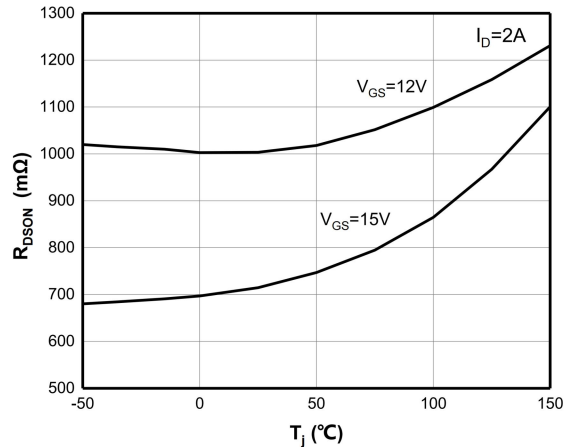

Fig.6 On-Resistance vs. Temperature for Various Gate Voltage



Typical Characteristics

Fig.7 Breakdown voltage vs. Temperature

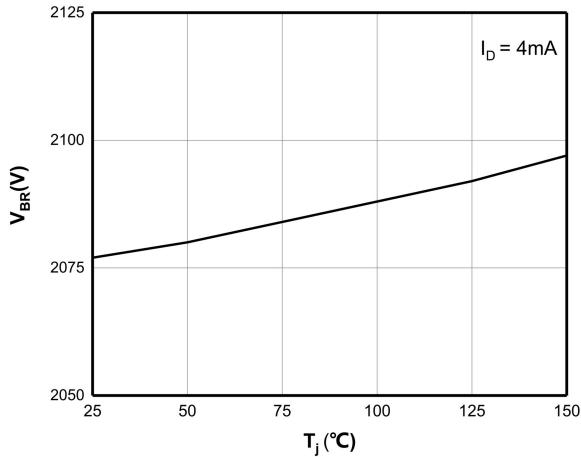

Fig.9 Capacitance vs. Drain-Source Voltage

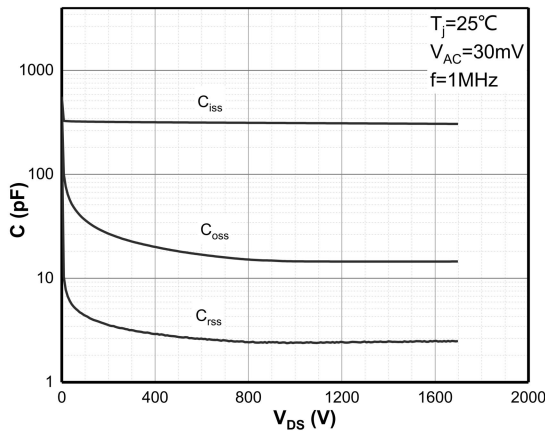

Fig.11 Continuous Drain Current Derating vs. Case Temperature

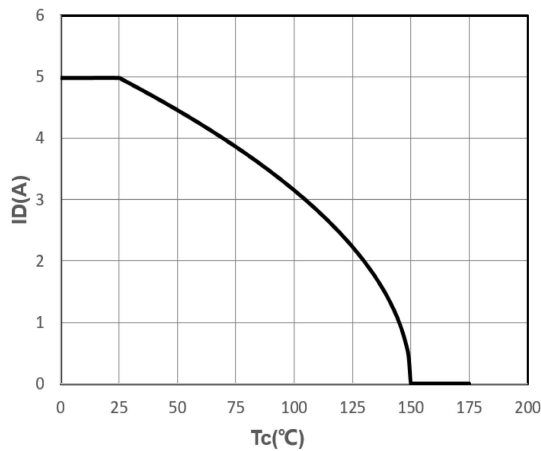

Fig.8 Body Diode Characteristics

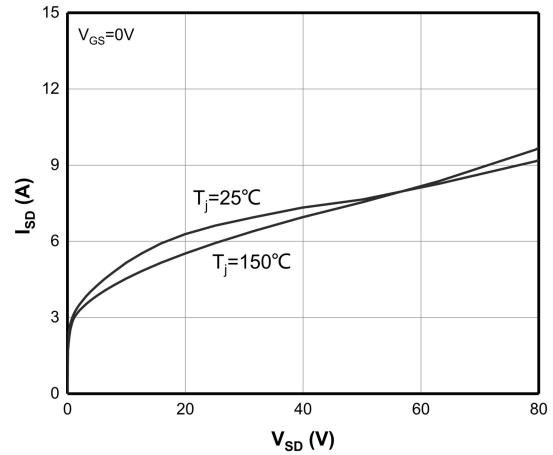

Fig.10 Gate Charge Characteristics

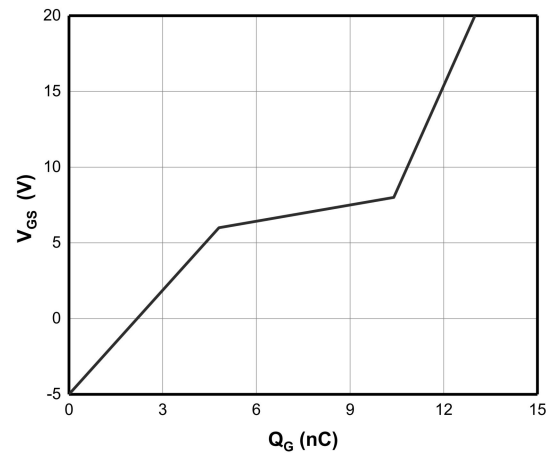
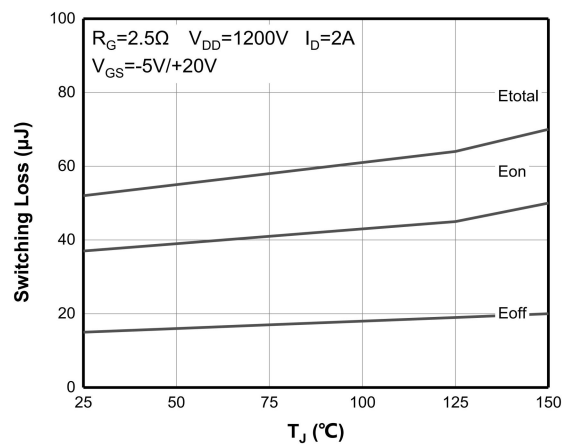

Fig.12 Clamped inductive switching energy vs. temperature



Typical Characteristics

Fig.13 Clamped Inductive Switching Energy vs. External Gate Resistance

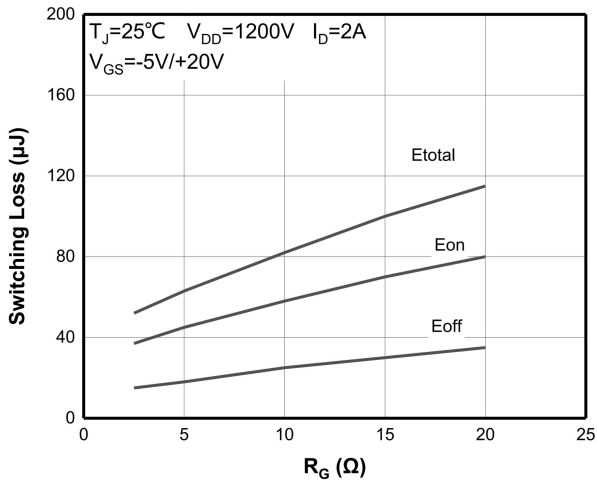

Fig.13 Safe Operating Area

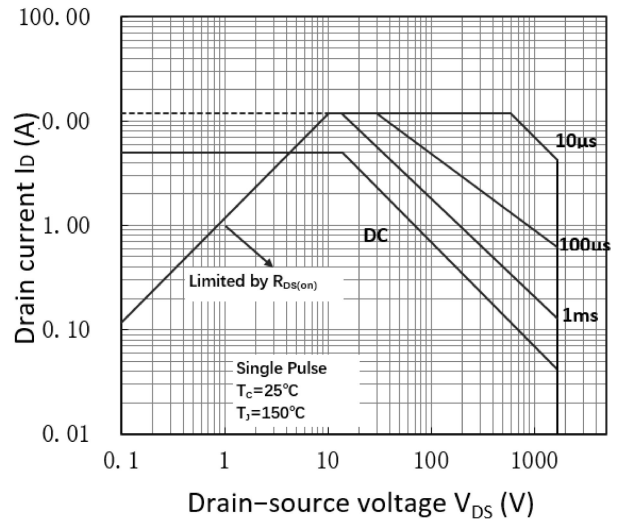
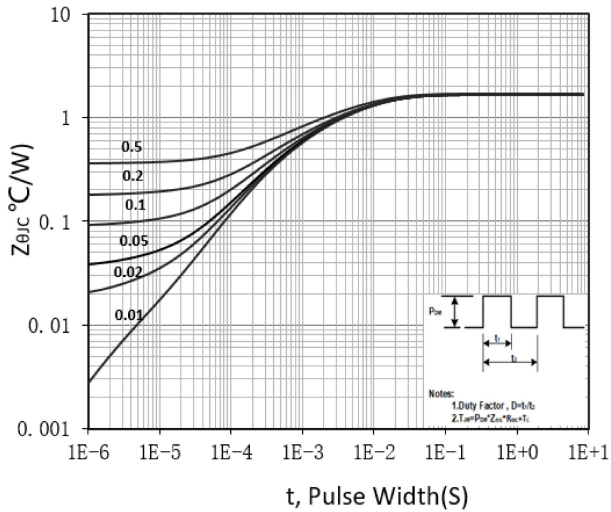

Fig.14 Transient Thermal Impedance (Junction – Case)



Ordering Information

Part	Package	Marking	Packing method
CTCM01KMA170T2C	TO-263-7L	1KMA170T2C	Tape and Reel

Package Information

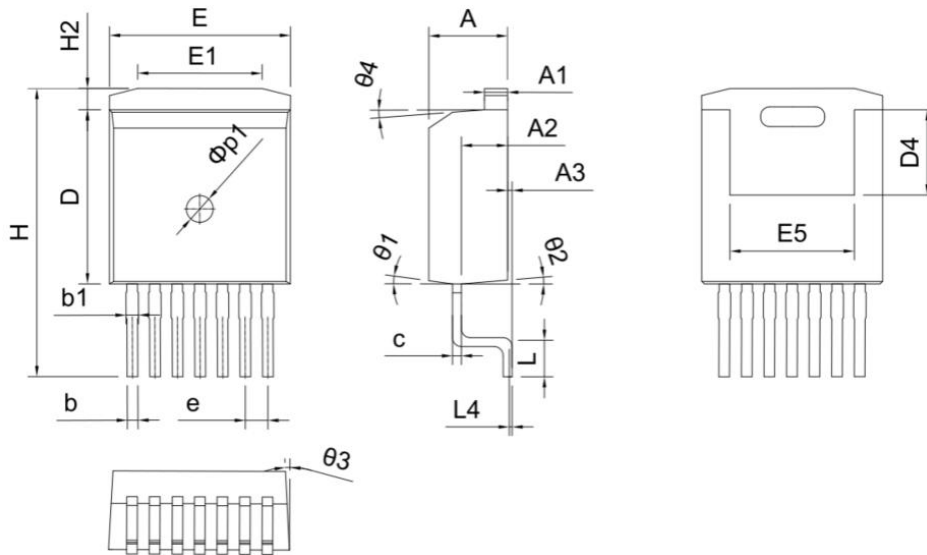

SYMBOL	mm		
	MIN	NOM	MAX
A	4.30	4.43	4.56
A1	1.20	1.30	1.40
A2	2.45	2.60	2.75
A3	0.00	0.13	0.25
b	0.50	0.60	0.70
b1	0.60	0.70	0.90
c	0.45	0.50	0.60
D	8.93	9.08	9.23
D4	4.65	4.80	4.95
E	10.08	10.18	10.28
E1	6.50	7.00	7.50
E5	6.82	7.22	7.62
e	1.27 BSC		
H	15.00	15.50	16.00
H2	0.98	1.20	1.42
L	1.90	2.20	2.50
L4	0.25 BSC		
$\phi p1$	1.40	1.50	1.60
$\theta1$	3°	5°	7°
$\theta2$	3°	5°	7°
$\theta3$	3°	5°	7°
$\theta4$	3°	5°	7°