

Descriptions

This is Silicon NPN transistor in a SOT-23 Plastic Package.

Features

- Collector currents up to 600 mA
- Halogen-free Product

Applications

General purpose amplifier.

Equivalent Circuit

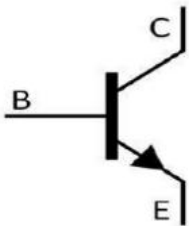

Pinning

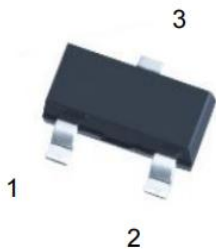

PIN1: Base PIN 2: Emitter PIN 3: Collector

hFE Classifications & Marking

h _{FE} Range	100~300
Marking	H1P

Absolute Maximum Ratings(Ta=25°C)

Parameter	Symbol	Rating	Unit
Collector to Base Voltage	V_{CBO}	75	V
Collector to Emitter Voltage	V_{CEO}	40	V
Emitter to Base Voltage	V_{EBO}	6.0	V
Collector Current	I_C	600	mA
Collector Power Dissipation	P_C	350	mW
Junction Temperature	T_J	150	°C
Storage Temperature Range	T_{stg}	-55~150	°C

Electrical Characteristics(Ta=25°C)

Parameter	Symbol	Test Conditions	Min	Typ	Max	Unit
Collector to Base Breakdown Voltage	V_{CBO}	$I_C=10\mu A$ $I_E=0$	75			V
Collector to Emitter Breakdown Voltage	V_{CEO}	$I_C=10mA$ $I_B=0$	40			V
Emitter to Base Breakdown Voltage	V_{EBO}	$I_E=10\mu A$ $I_C=0$	6.0			V
Collector Cut-Off Current	I_{CBO}	$V_{CB}=60V$ $I_E=0$			0.01	μA
Base Cut-Off Current	I_{EBO}	$V_{EB}=5.0V$ $I_C=0$			0.1	μA
DC Current Gain	$h_{FE(1)}$	$V_{CE}=10V$ $I_C=150mA^*$	100		300	
Collector-Emitter Saturation Voltage	$V_{CE(sat)(1)}$	$I_C=150mA$ $I_B=15mA$			0.3	V
	$V_{CE(sat)(2)}$	$I_C=500mA$ $I_B=50mA$			1.0	V
Base-Emitter Saturation Voltage	$V_{BE(sat)(1)}$	$I_C=150mA$ $I_B=15mA$	0.6		1.2	V
	$V_{BE(sat)(2)}$	$I_C=500mA$ $I_B=50mA$			2.0	V
Output Capacitance	C_{ob}	$V_{CB}=10V$ $f=1.0MHz$ $I_E=0$			8.0	pF
Transition Frequency	f_T	$I_C=20mA$ $V_{CE}=20V$ $f=100MHz$	300			MHz
Turn-On Time	t_{on}	$V_{CC}=30V$ $V_{BE}=-0.5V$ $I_C=150mA$ $I_{B1}=15mA$			35	ns
Turn-Off Time	t_{off}	$V_{CC}=30V$ $I_C=150mA$ $I_{B1}=I_{B2}=15mA$			285	ns

Electrical Characteristic Curve

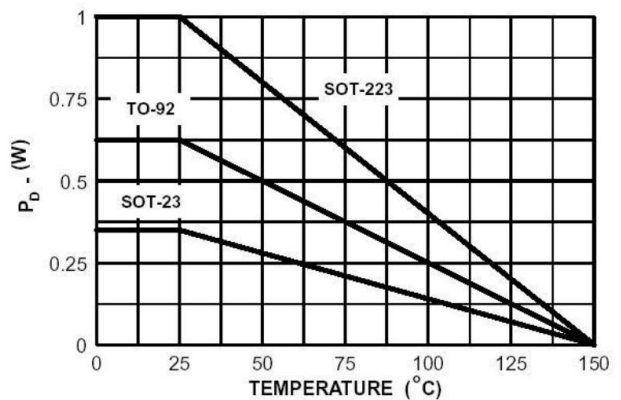
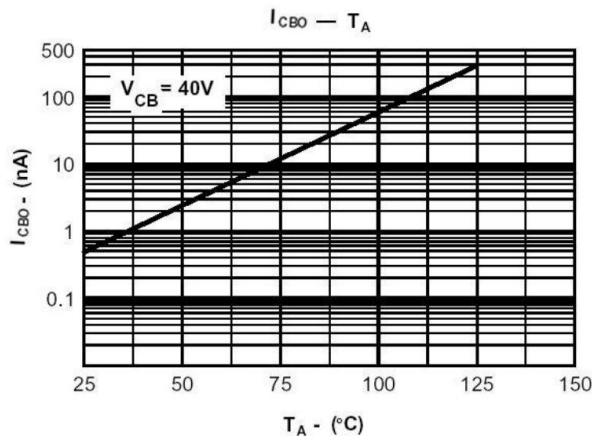
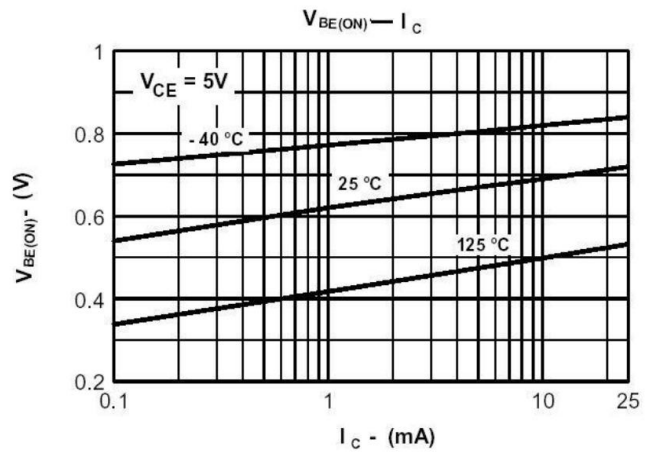
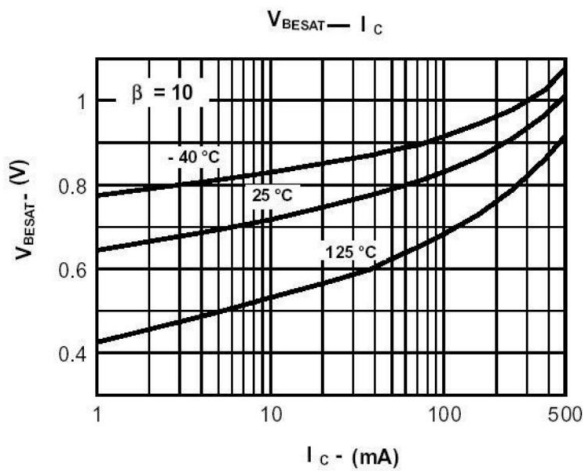
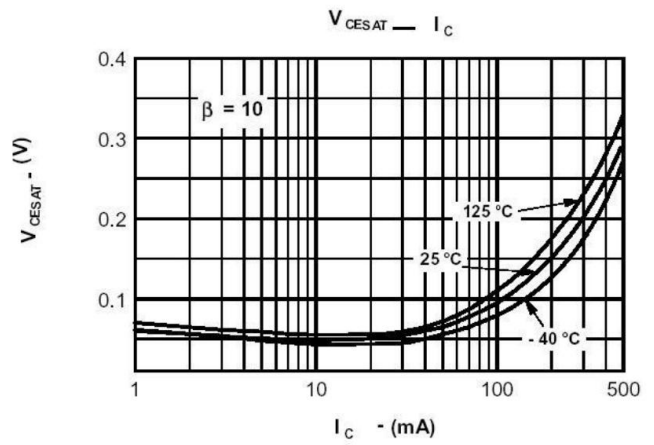
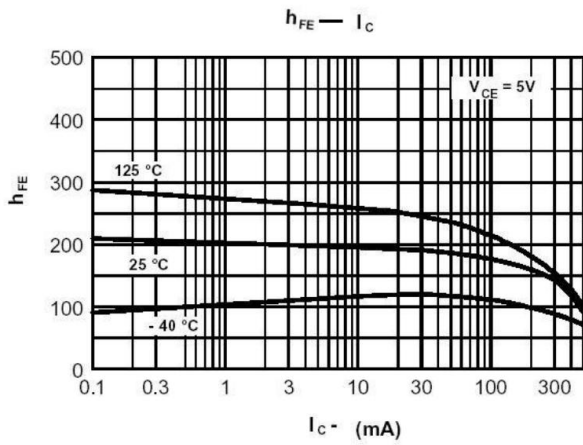

Marking Instructions

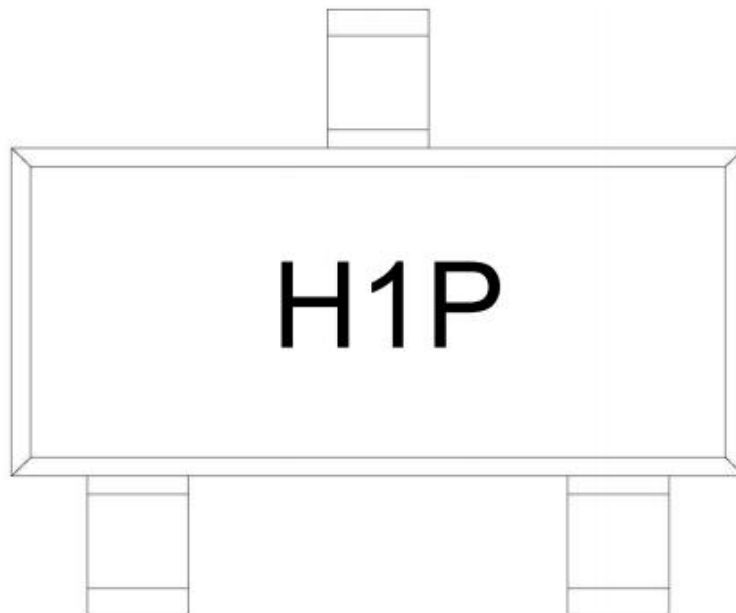

Note:

- H: Company Code
- 1P: Product Type Code

Packaging SPEC.

REEL INFORMATION

Package Type	Units					Dimension (unit: mm ³)		
	Units/Reel	Reels/Inner Box	Units/Inner Box	Inner Boxes/Outer Box	Units/Outer Box	Reel	Inner Box	Outer Box
SOT-23	3,000	10	30,000	6	180,000	7" x8	180x120x180	390x385x205

Package Dimensions

SOT-23

单位: mm

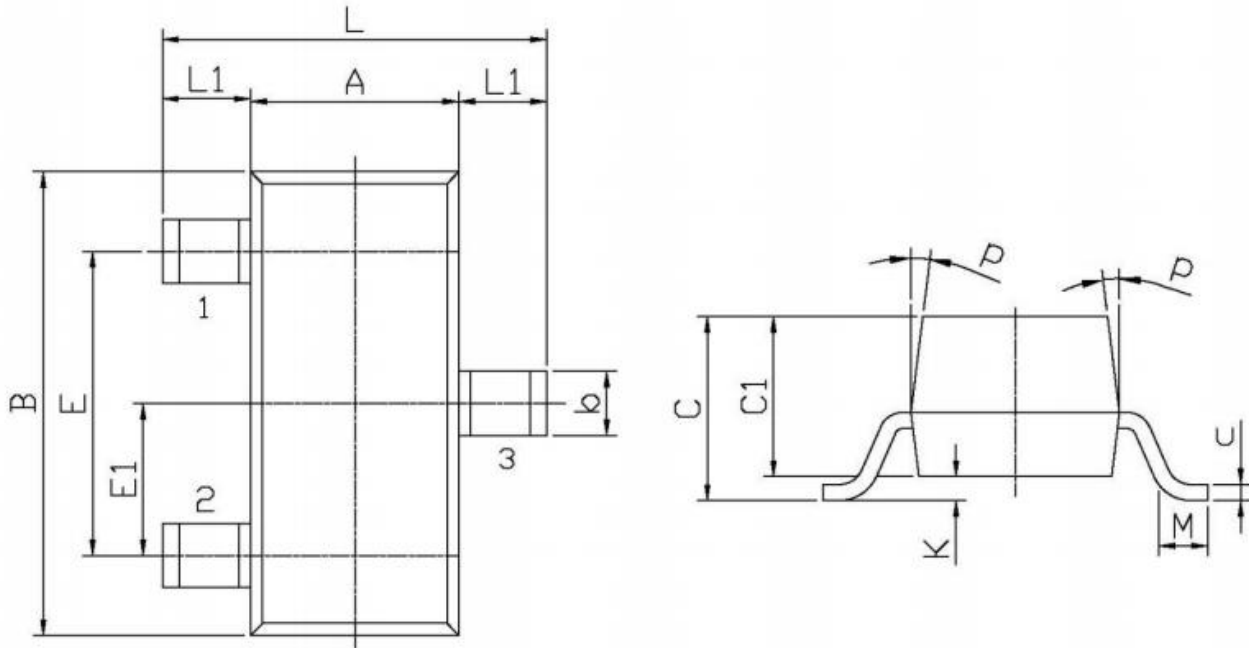

Symbol	Dimensions In Millimeters		Symbol	Dimensions In Millimeters	
	Min	Max		Min	Max
L	2.2	2.7	C	1.30Max	
L1	0.45	0.65	C1	0.90	1.20
A	1.15	1.50	c	0.05	0.20
B	2.70	3.10	K	0	0.10
E	1.70	2.10	M	0.20MIN	
E1	0.85	1.05	P	7°	
b	0.35	0.55			