

Description

1.0A Surface Mount Glass Passivated Bridge Rectifier, ABF thin package.

Features

- Glass Passivated Chip Junction
- Reverse Voltage: 1000V
- Forward Current:1.0A
- Fast reverse recovery time
- Designed for Surface Mount Application
- Halogen free product

Applications

- Computing Power / Desktop Power
- Game Console Power
- Server Power
- Air Conditioner out door power board
- High Power/High Efficiency Power
- Home Appliances Power Board

Equivalent Circuit & Pinning

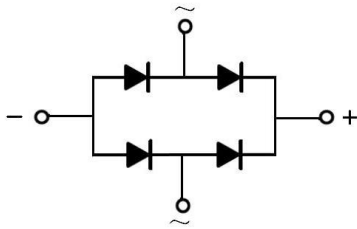

PIN	DESCRIPTION
1	Input Pin (~)
2	Input Pin (~)
3	Output Anode (+)
4	Output Cathode (-)

The recommended mounting pad size

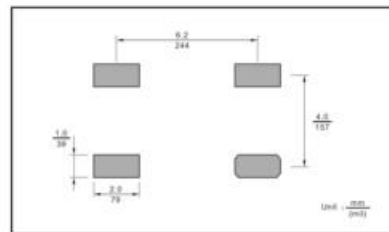

Absolute Maximum Ratings(Ta=25°C)

Parameter	Symbol	Rating	Unit
Maximum Repetitive Peak Reverse Voltage	V_{RRM}	1000	V
Maximum RMS Voltage	V_{RMS}	700	V
Maximum DC Blocking Voltage	V_{DC}	1000	V
Average Rectified Output Current at $T_c = 125^\circ\text{C}$	I_o	1.0	A
Peak Forward Surge Current 8.3 ms Single Half Sine Wave Superimposed on Rated Load	I_{FSM}	30	A
Typical Junction Capacitance ^(Note1)	C_j	30	pF
Typical Thermal Resistance ^(Note2)	$R_{\theta JA}$	75	$^\circ\text{C}/\text{W}$
Operating and Storage Temperature Range	T_j, T_{stg}	-55~150	$^\circ\text{C}$

Note:

1. Measured at 1MHz and applied reverse voltage of 4 V D.C.
2. Mounted on glass epoxy PC board with 4×1.0" X 1.0" (2.54 X 2.54 cm) copper pad.

Electrical Characteristics(Ta=25°C)

Parameter	Symbol	Test Conditions	Rating	Unit
Forward Voltage per element	V_F	$I_F=1.0\text{A}$	1.3	V
Maximum DC Reverse Current at Maximum DC Blocking Voltage	I_R	$T_a=25^\circ\text{C}$	5.0	μA
		$T_a=125^\circ\text{C}$	50	μA
Maximum Reverse Recovery Time	t_{rr}	$I_F=0.5\text{A}$ $I_R=1.0\text{A}$ $I_{rr}=0.25\text{A}$	200	ns

Electrical Characteristic Curve

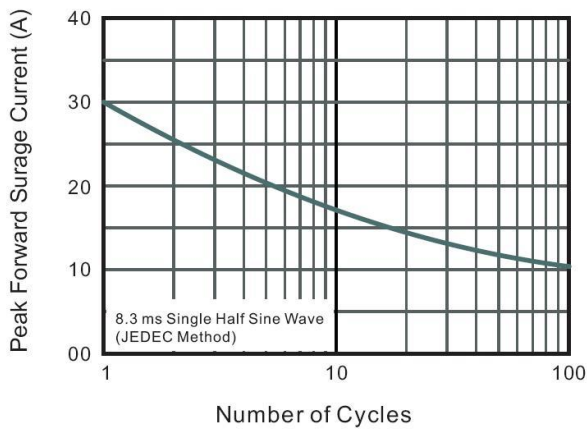
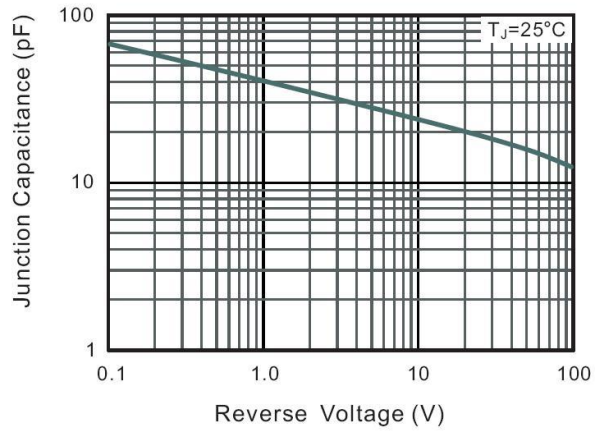
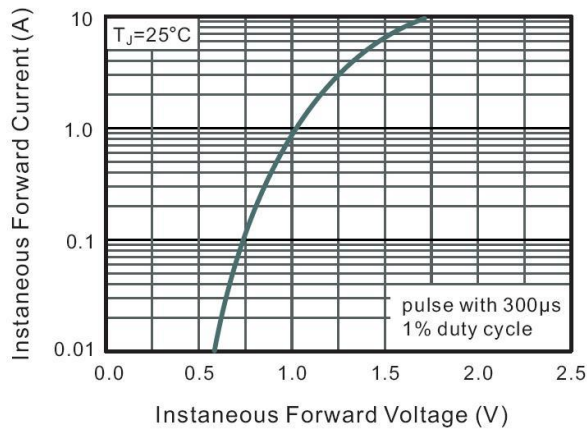
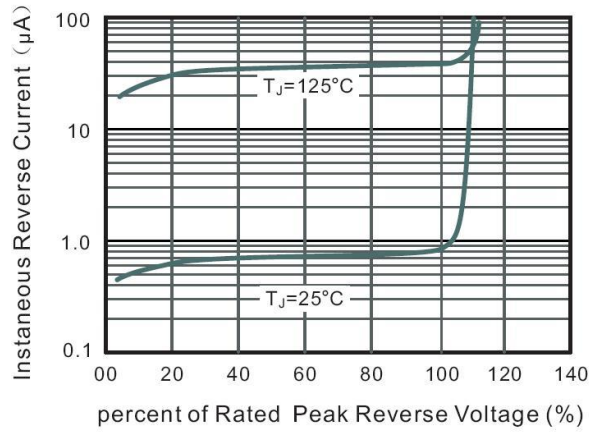
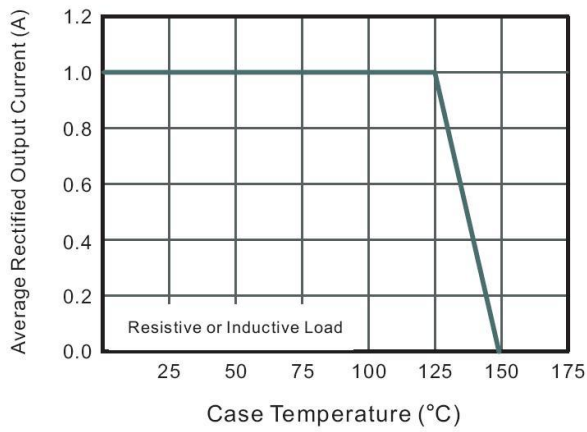

Marking Instructions

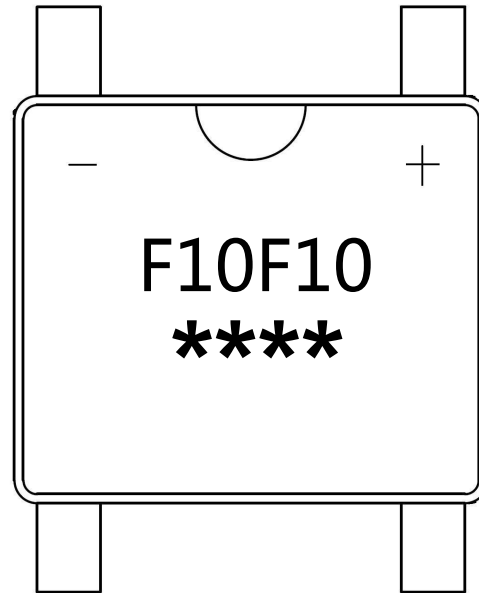

F10F10 : Product Type Code

**** : Lot No. Code , The 1st * means:YM Code , The last 3 * means:little Lot No Code

Packaging SPEC.

REEL INFORMATION

Package Type	Units					Dimension (unit: mm ³)		
	Units/Reel	Reels/Inner Box	Units/Inner Box	Inner Boxes/Outer Box	Units/Outer Box	Reel	Inner Box	Outer Box
ABF	5000	2	10000	5	50000	13" ×15	336X336X40	380X335X366

Package Outline Dimensions

ABF

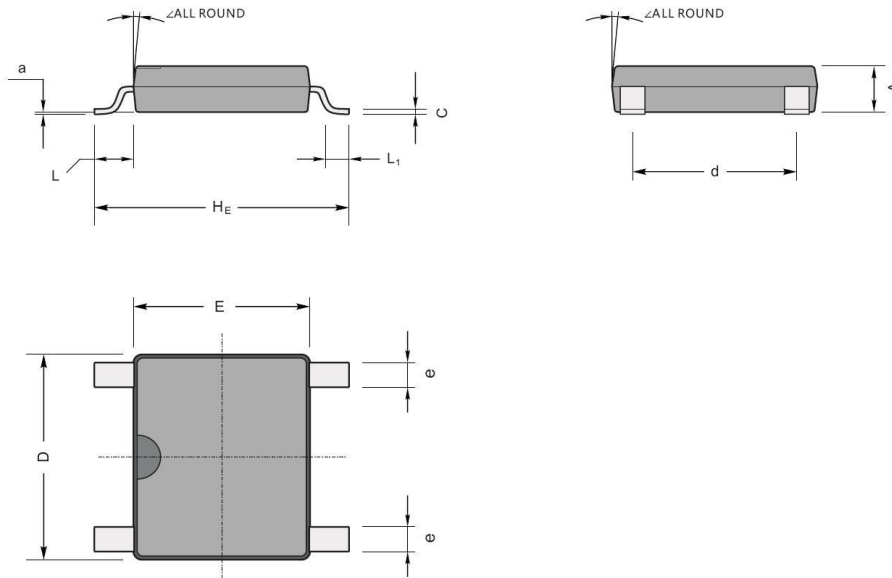

ABF mechanical data

UNIT		A	C	D	E	H_E	d	e	L	L_1	a	\angle
mm	max	1.2	0.22	5.2	4.5	6.4	4.2	0.7	0.95	0.6	0.2	7°
	min	1.0	0.15	4.9	4.2	6.0	3.8	0.5				
mil	max	47	8.7	205	177	252	165	28	37	24	8	
	min	39	5.9	193	166	236	150	20				