

Descriptions

This -40A, -30V P-Channel MOSFET in a TO-252 Plastic Package.

Features

- High Current Capability
- Halogen-free Product

Applications

AC-in load switch, Battery protection charge/discharge.

Equivalent Circuit

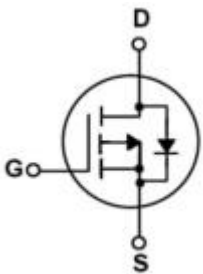

Pinning



PIN1: Gate PIN 2: Drain PIN 3: Source PIN 4: Drain

Absolute Maximum Ratings(Ta=25°C)

Parameter		Symbol	Rating	Unit
Drain-Source Voltage		V_{DSS}	-30	V
Drain Current		$I_D(T_C=25^\circ C)$	-40	A
Drain Current - Pulsed		I_{DM}	-140	A
Gate-Source Voltage		V_{GS}	± 20	V
Avalanche Current		I_{AS}	22	A
Avalanche energy L=0.5mH		E_{AS}	662.7	mJ
Power Dissipation		$P_D(T_C=25^\circ C)$	44	W
		$P_D(T_C=100^\circ C)$	17	W
Junction and Storage Temperature Range		T_j, T_{stg}	-55~150	°C
Maximum Junction-to-Ambient	t ≤ 10s	$R_{\theta JA}$	11	°C/W
Maximum Junction-to-Ambient	Steady-State		29	
Maximum Junction-to-Case	Steady-State	$R_{\theta JC}$	2.8	

Electrical Characteristics(Ta=25°C)

Parameter	Symbol	Test Conditions	Min	Typ	Max	Unit
Drain-Source Breakdown Voltage	BV_{DSS}	$V_{GS}=0V$ $I_D=-250\mu A$	-30	-36		V
Zero Gate Voltage Drain Current	I_{DSS}	$V_{DS}=-30V$ $V_{GS}=0V$			-1.0	μA
		$V_{DS}=-30V$ $V_{GS}=0V$ $T_J=55^\circ C$			-5.0	μA
Gate-Body Leakage Current Forward	I_{GSS}	$V_{GS}=\pm 20V$ $V_{DS}=0V$			± 0.1	μA
Gate Threshold Voltage	$V_{GS(th)}$	$V_{DS}=V_{GS}$ $I_D=250\mu A$	-1	-1.6	-2.5	V
Static Drain-Source On-Resistance	$R_{DS(on)1}$	$V_{GS}=-10V$ $I_D=-30A$		13	16	mΩ
	$R_{DS(on)2}$	$V_{GS}=-4.5V$ $I_D=-20A$		24	28	mΩ
Diode Forward Voltage	V_{SD}	$I_S=-1A$ $V_{GS}=0V$		-0.9	-1.2	V

Electrical Characteristics(Ta=25°C)

Parameter	Symbol	Test Conditions	Min	Typ	Max	Unit
Input Capacitance	C_{iss}	$V_{DS}=-0V$ $V_{GS}=0V$ $f=1.0MHz$		2530		pF
Output Capacitance	C_{oss}			790		
Reverse Transfer Capacitance	C_{rss}			450		
Gate resistance	R_g	$V_{GS}=0V$ $V_{DS}=0V$ $f=1MHz$		8		Ω
Total Gate Charge	$Q_g(10V)$	$V_{GS}=-10V$ $V_{DS}=-15V$ $I_D=-20A$		50	70	nC
Total Gate Charge	$Q_g(4.5V)$			25	35	
Gate Source Charge	Q_{gs}			9		
Gate Drain Charge	Q_{gd}			12		
Turn-On Delay Time	$t_{d(on)}$	$V_{GS}=-10V$ $V_{DS}=-15V$ $R_L=0.75\Omega$ $R_{GEN}=3\Omega$		12.5		ns
Turn-On Rise Time	t_r			18		
Turn-Off Delay Time	$t_{d(off)}$			125		
Turn-Off Fall Time	t_f			66		

Electrical Characteristic Curve

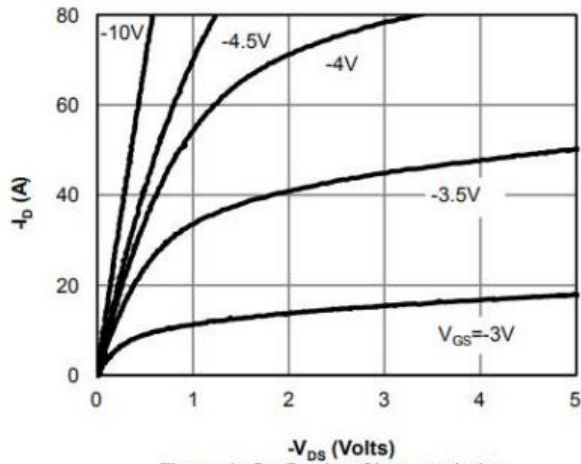

Figure 1: On-Region Characteristics

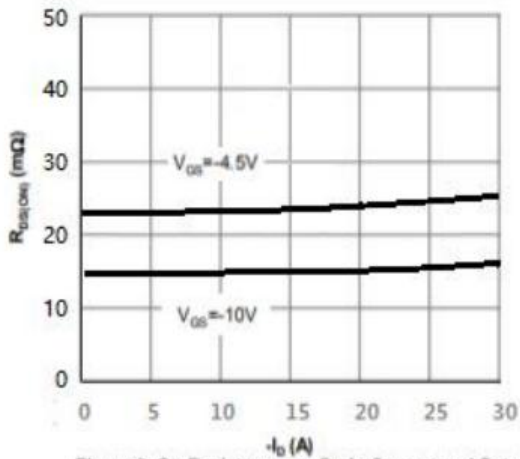
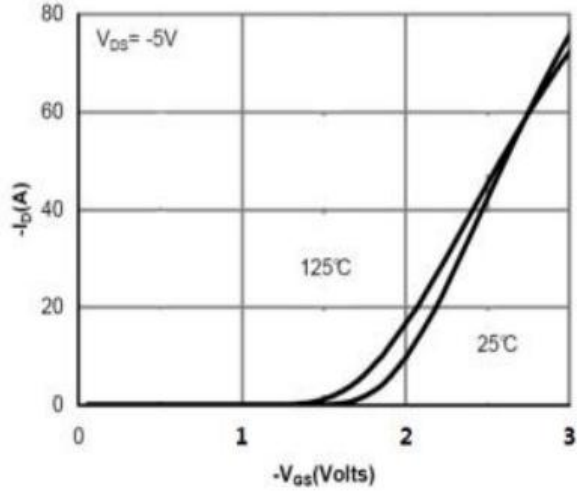

Figure 3: On-Resistance vs. Drain Current and Gate Voltage

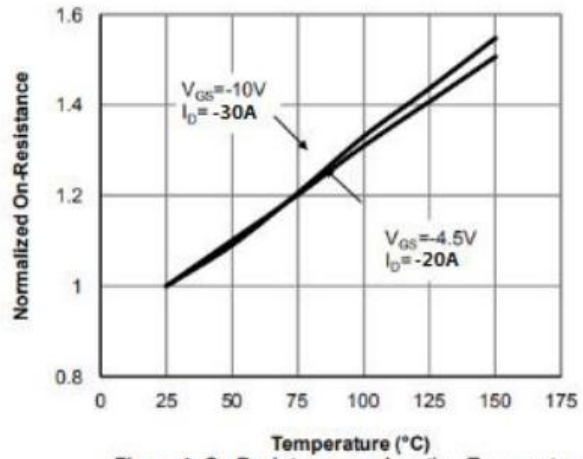

Figure 4: On-Resistance vs. Junction Temperature

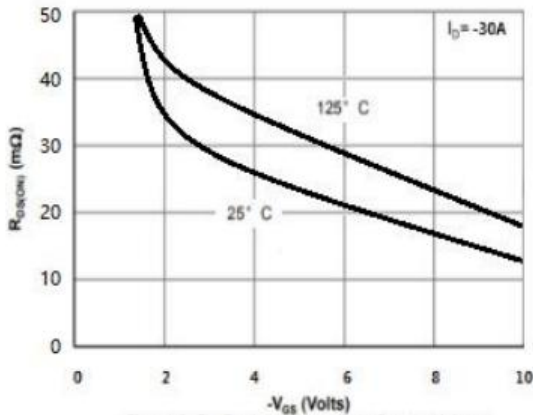

Figure 5: On-Resistance vs. Gate-Source Voltage

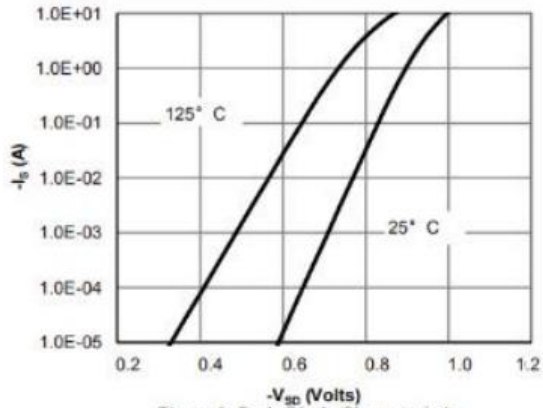

Figure 6: Body-Diode Characteristics

Electrical Characteristic Curve

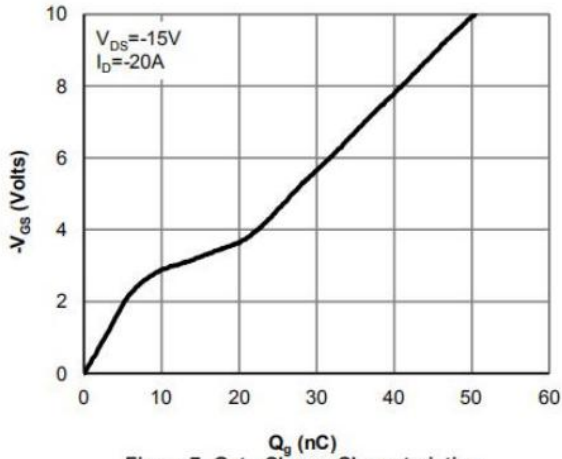

Figure 7: Gate-Charge Characteristics

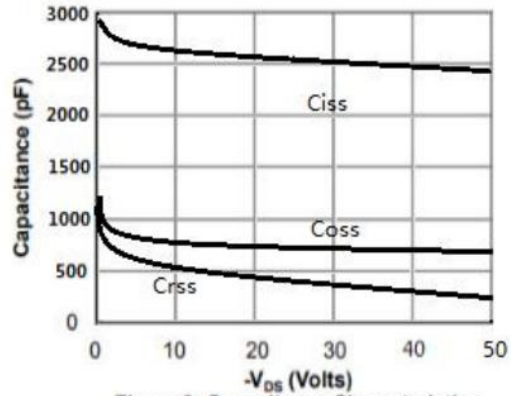

Figure 8: Capacitance Characteristics

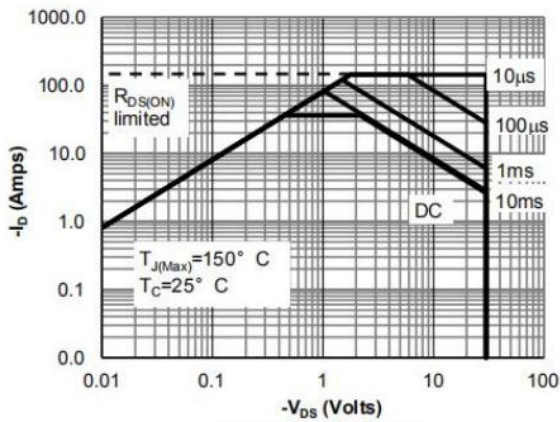

Figure 9: Maximum Forward Biased Safe Operating Area

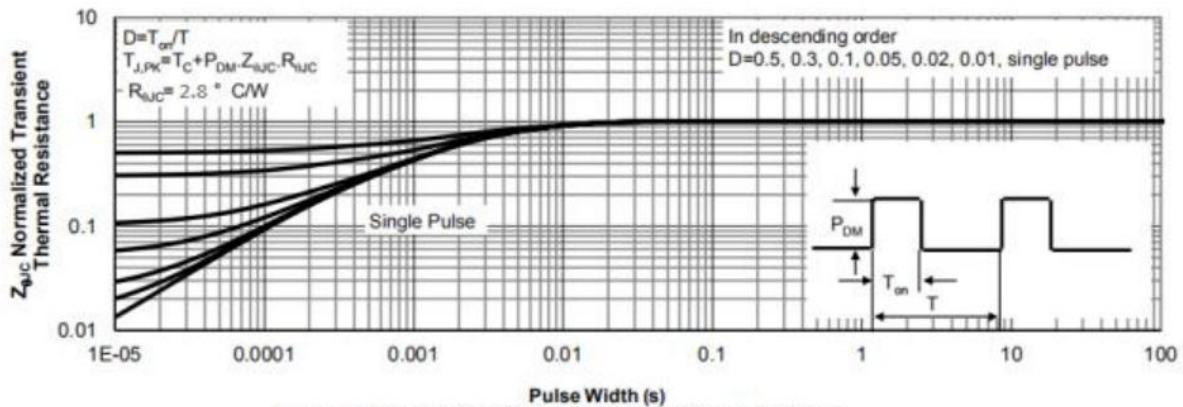
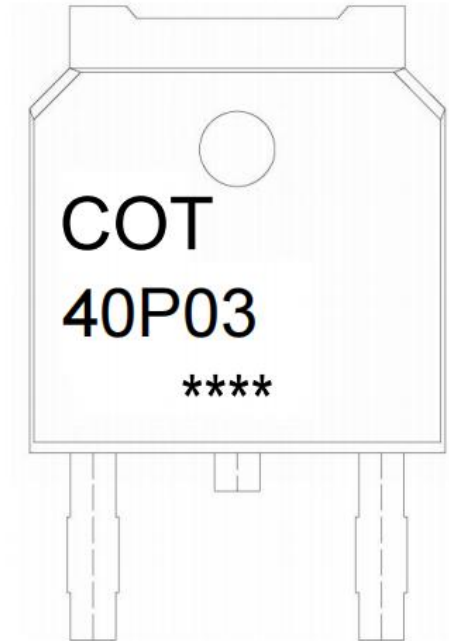

Figure 10: Normalized Maximum Transient Thermal Impedance

Marking Instructions



Note:

COT: Company Logo

40P03: Product Type.

****: Lot No. Code, code change with Lot No.

Packaging SPEC

REEL INFORMATION

Package Type	Units					Dimension (unit: mm ³)		
	Units/Reel	Reels/Inner Box	Units/Inner Box	Inner Boxes/Outer Box	Units/Outer Box	Reel	Inner Box	Outer Box
TO-252	2,500	2	5,000	6	30,000	13" ×16	360×360×50	380×335×366

TUBE INFORMATION

Package Type	Units					Dimension (unit: mm ³)		
	Units/Tube	Tubes/Inner Box	Units/Inner Box	Inner Boxes/Outer Box	Units/Outer Box	Tube	Inner Box	Outer Box
TO-252	75	48	3,600	5	18,000	526×20.5×5.25	555×164×50	575×290×180

Package Outline Dimensions

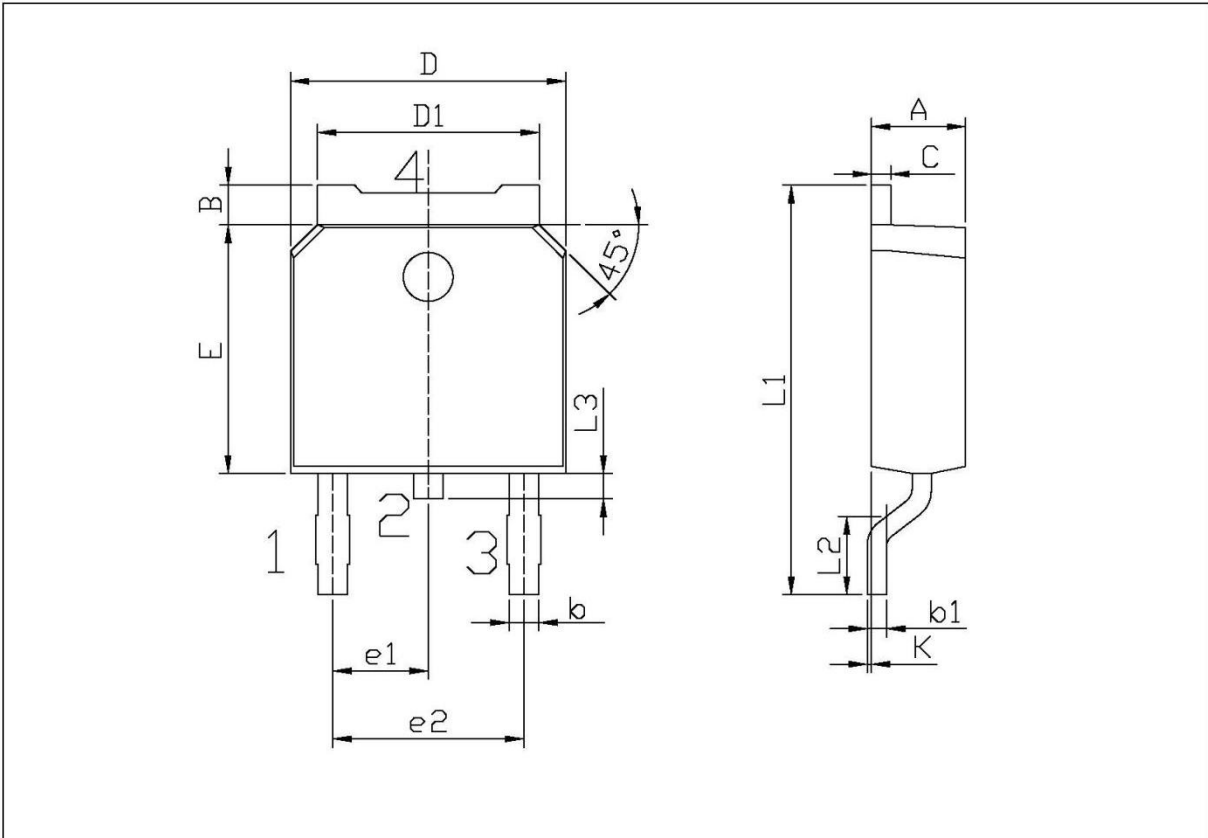

单位: mm

Symbol	Dimensions In Millimeters		Symbol	Dimensions In Millimeters	
	Min	Max		Min	Max
A	2.20	2.40	E	5.95	6.25
B	0.95	1.25	e1	2.24	2.34
b	0.70	0.90	e2	4.43	4.73
b1	0.45	0.55	L1	9.85	10.35
C	0.45	0.55	L2	1.70	2.00
D	6.45	6.75	L3	0.60	0.90
D1	5.10	5.50	K	0.00	0.10

TO-252