

Descriptions

Silicon NPN transistor in a TO-252 Plastic Package.

Features

- Low saturation voltage
- Excellent h_{FE} linearity and high h_{FE} .
- Halogen-free Product

Applications

- Output stage of 3 watts audio amplifier
- Voltage regulator
- DC-DC converter and relay driver

Equivalent Circuit & Pinning

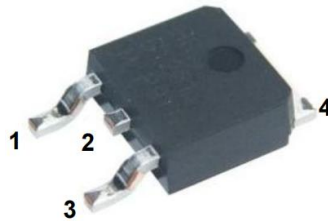
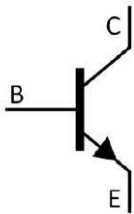

PIN1: Base PIN 2,4: Collector PIN 3: Emitter

h_{FE} Classifications & Marking

h_{FE} Classifications Symbol	R	Q	P	E
h_{FE} Range	60~120	100~200	160~320	200~400

Absolute Maximum Ratings(Ta=25°C)

Parameter	Symbol	Rating	Unit
Collector to Base Voltage	V_{CBO}	40	V
Collector to Emitter Voltage	V_{CEO}	30	V
Emitter to Base Voltage	V_{EBO}	5.0	V
Collector Current - Continuous	I_C	3.0	A
Collector Power Dissipation	P_C	1.0	W
	$P_{C(Tc=25^{\circ}C)}$	10	W
Junction Temperature	T_j	150	°C
Storage Temperature Range	T_{stg}	-55~150	°C

Electrical Characteristics(Ta=25°C)

Parameter	Symbol	Test Conditions	Min	Typ	Max	Unit
Collector Cut-Off Current	I_{CBO}	$V_{CB}=30V$ $I_E=0$			1.0	μA
Emitter Cut-Off Current	I_{EBO}	$V_{EB}=3.0V$ $I_C=0$			1.0	μA
DC Current Gain	$h_{FE(1)}$	$V_{CE}=2.0V$ $I_C=1.0A$	60	160	400	
	$h_{FE(2)}$	$V_{CE}=2.0V$ $I_C=20mA$	30	150		
Collector to Emitter Saturation Voltage	$V_{CE(sat)}$	$I_C=2.0A$ $I_B=0.2A$		0.3	0.5	V
Base to Emitter Saturation Voltage	$V_{BE(sat)}$	$I_C=2.0A$ $I_B=0.2A$		1.0	2.0	V
Transition Frequency	f_T	$V_{CE}=5.0V$ $I_C=0.1A$		90		MHz
Collector output capacitance	C_{ob}	$V_{CB}=10V$ $f=1.0MHz$		45		pF

Electrical Characteristic Curve

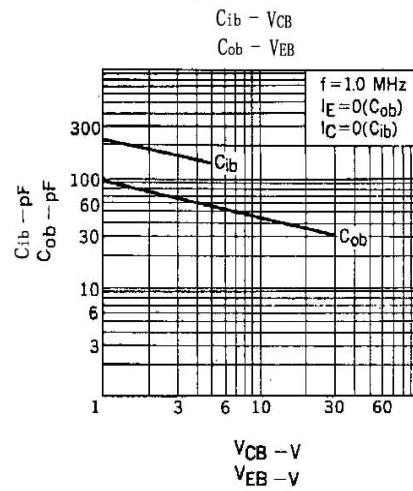
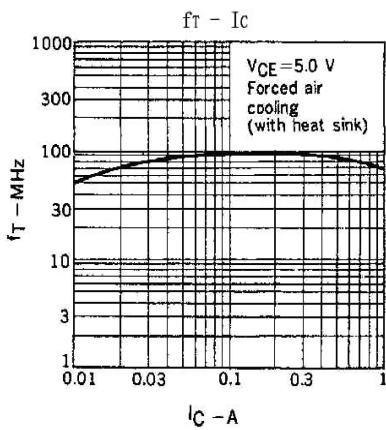
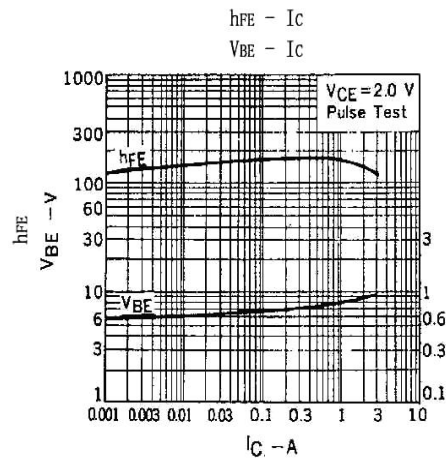
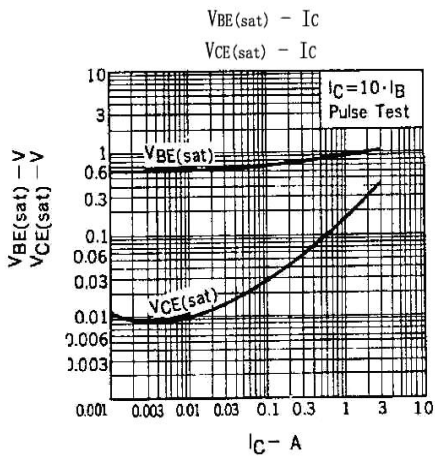
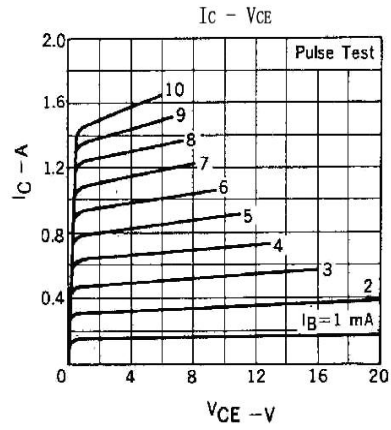
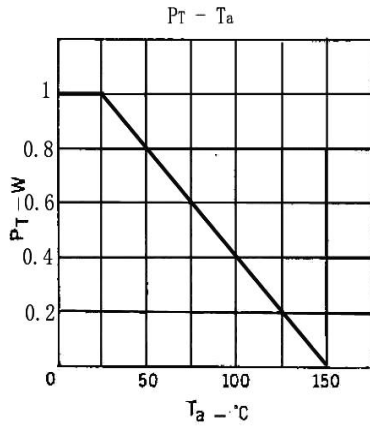

Marking Instructions

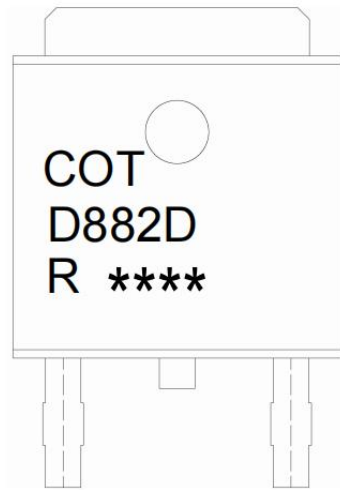

Note:

- COT: Company Code
- D882D: Product Type.
- R: h_{FE} Classifications Symbol
- ****: Lot No. Code, code change with Lot No.

h _{FE} Classifications Symbol	R	Q	P	E
h _{FE} Range	60~120	100~200	160~320	200~400

Packaging SPEC

REEL

Package Type	Units					Dimension (unit: mm ³)		
	Units/Reel	Reels/Inner Box	Units/Inner Box	Inner Boxes/Outer Box	Units/Outer Box	Reel	Inner Box	Outer Box
TO-252	2,500	2	5,000	5	25,000	13" x16	360x360x50	385x257x392

TUBE

Package Type	Units					Dimension (unit: mm ³)		
	Units/Tube	Tubes/Inner Box	Units/Inner Box	Inner Boxes/Outer Box	Units/Outer Box	Tube	Inner Box	Outer Box
TO-251/252	75	48	3,600	5	18,000	526x20.5x5.25	555x164x50	575x290x180

Package Outline Dimensions

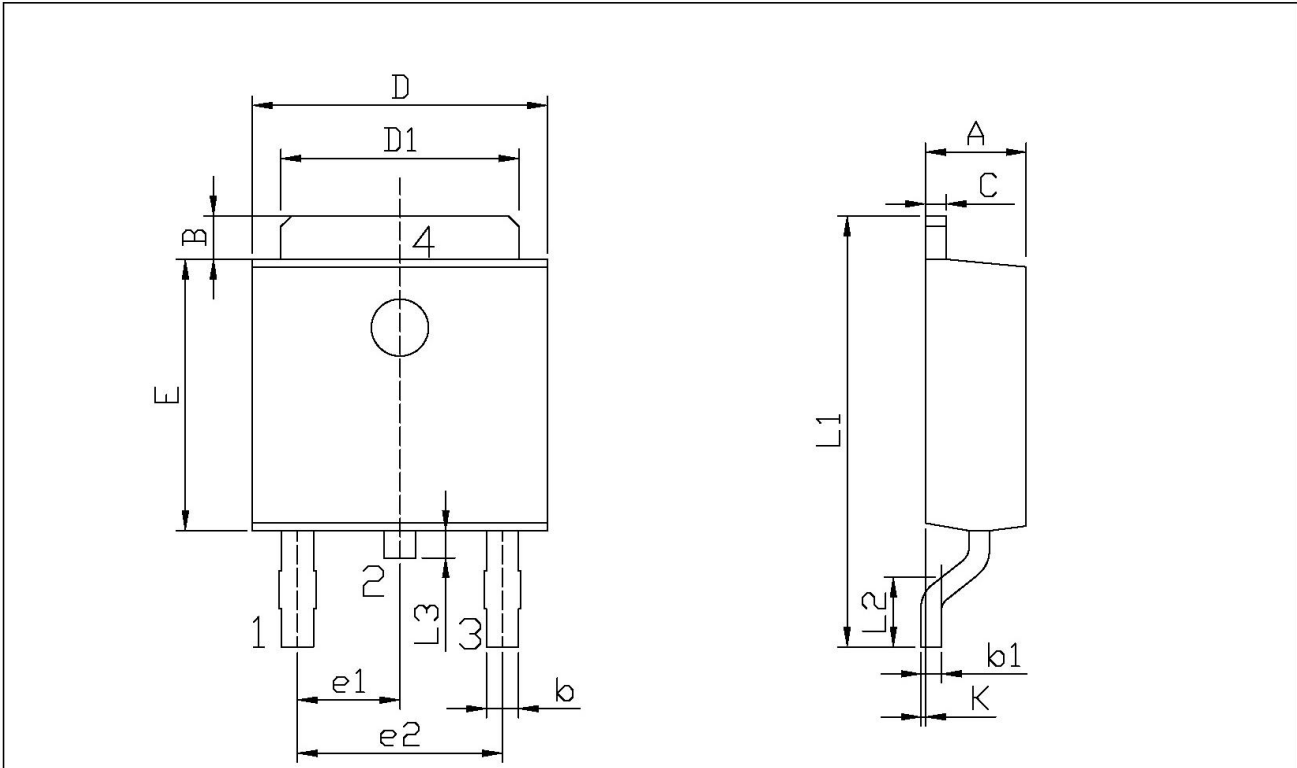

单位: mm

Symbol	Dimensions In Millimeters		Symbol	Dimensions In Millimeters	
	Min	Max		Min	Max
A	2.20	2.40	E	5.95	6.25
B	0.95	1.25	e1	2.24	2.34
b	0.50	0.90	e2	4.43	4.73
b1	0.45	0.55	L1	9.45	9.95
C	0.45	0.55	L2	1.25	1.75
D	6.45	6.75	L3	0.60	0.90
D1	5.10	5.50	K	0.00	0.10

TO-252