

Descriptions

Silicon NPN transistor in a SOT-23 Plastic Package

Features

- Excellent h_{FE} linearity
- High h_{FE}
- Low noise
- Halogen-free Product

Applications

General power amplifier and switching application

Equivalent Circuit & Pinning

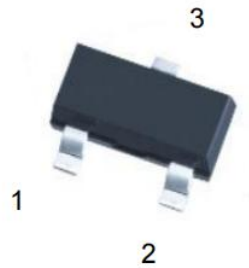
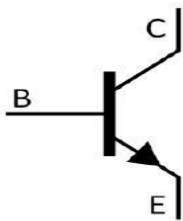

PIN1: Base

PIN 2: Emitter

PIN 3: Collector

h_{FE} Classifications & Marking

h_{FE} Classifications Symbol	O	Y	GR	BL
h_{FE} Range	70~140	120~240	200~400	350~700
Marking	HALO	HALY	HALG	HALB

Absolute Maximum Ratings(Ta=25°C)

Parameter	Symbol	Rating	Unit
Collector to Base Voltage	V_{CBO}	60	V
Collector to Emitter Voltage	V_{CEO}	50	V
Emitter to Base Voltage	V_{EBO}	5.0	V
Collector Current	I_C	150	mA
Base Current	I_B	30	mA
Collector Power Dissipation	P_C	150	mW
Junction Temperature	T_j	150	°C
Storage Temperature Range	T_{stg}	-55~150	°C

Electrical Characteristics(Ta=25°C)

Parameter	Symbol	Test Conditions	Min	Typ	Max	Unit
Collector to Emitter Breakdown Voltage	V_{CBO}	$I_C=100\mu A$ $I_E=0$	60			V
Collector to Base Breakdown Voltage	V_{CEO}	$I_C=500\mu A$ $I_B=0$	50			V
Emitter to Base Breakdown Voltage	V_{EBO}	$I_E=100\mu A$ $I_C=0$	5.0			V
Collector Cut-Off Current	I_{CBO}	$V_{CB}=60V$ $I_E=0$			0.1	μA
Emitter Cut-Off Current	I_{EBO}	$V_{EB}=5.0V$ $I_C=0$			0.1	μA
DC Current Gain	h_{FE}	$V_{CE}=6.0V$ $I_C=2.0mA$	70		700	
Collector to Emitter Saturation Voltage	$V_{CE(sat)}$	$I_C=100mA$ $I_B=10mA$		0.1	0.25	V
Transition Frequency	f_T	$V_{CE}=10V$ $I_C=1.0mA$	80			MHz
Collector output capacitance	C_{ob}	$V_{CB}=10V$ $f=1.0MHz$ $I_E=0$		2.0	3.5	pF
Noise Figure	NF	$V_{CB}=6.0V$ $f=1KHz$ $I_C=0.1mA$ $R_g=10K\Omega$		1.0	10	dB

Electrical Characteristic Curve

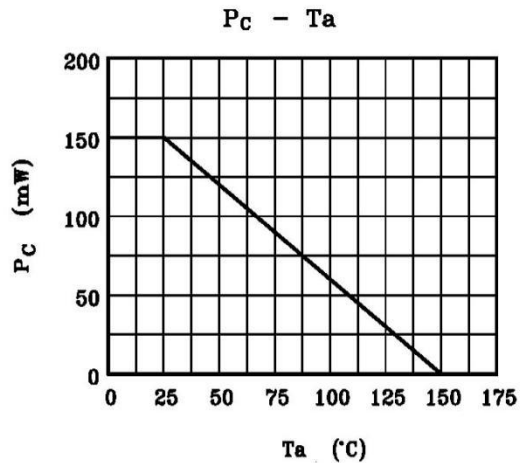
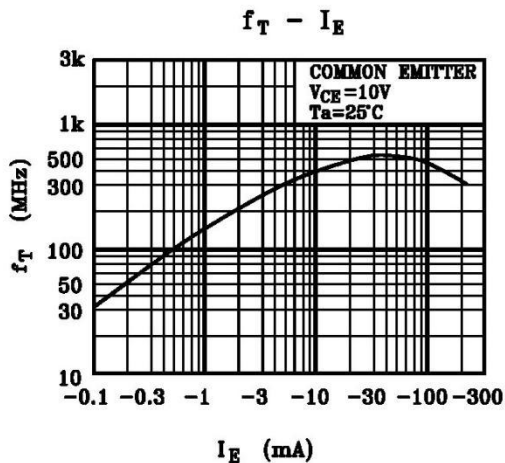
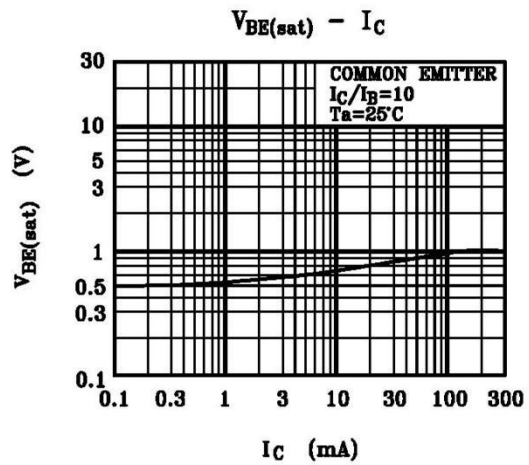
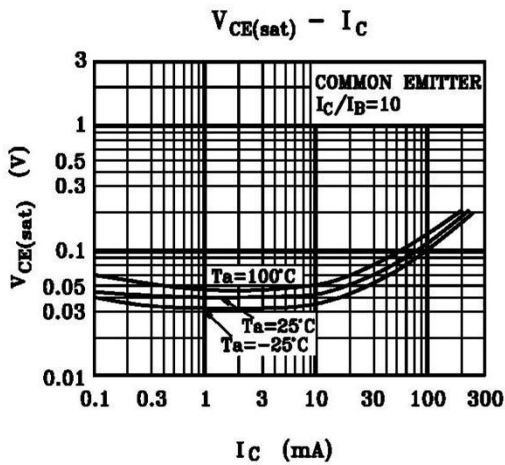
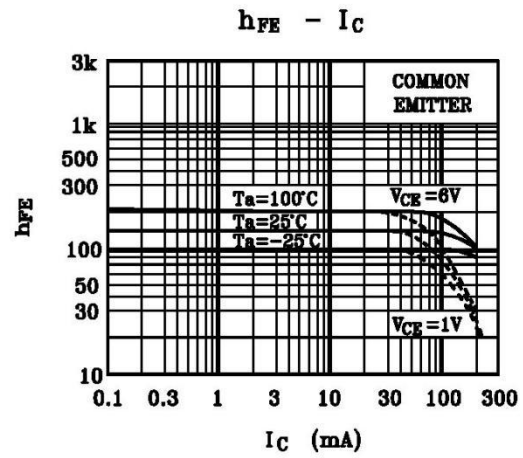
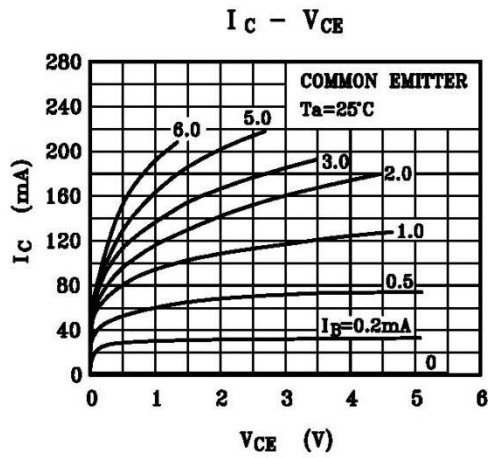

Marking Instructions

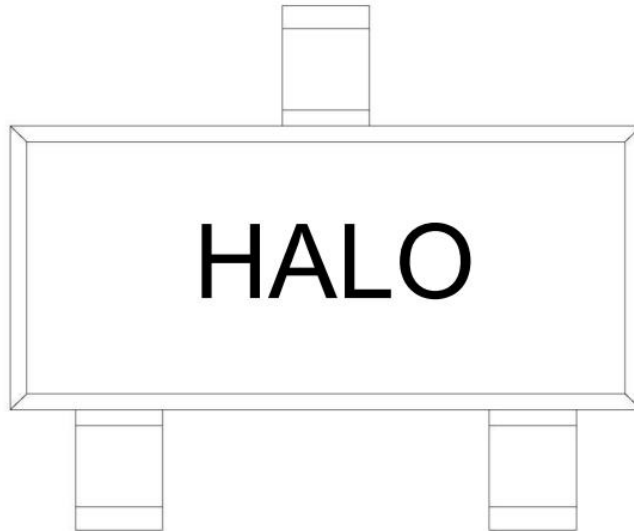

Note:

- H: Company Code
- AL: Product Type
- O: h_{FE} Classifications Symbol

h_{FE} Classifications Symbol	O	Y	GR	BL
h_{FE} Range	70~140	120~240	200~400	350~700
Marking	HALO	HALY	HALG	HALB

Packaging SPEC

REEL INFORMATION

Package Type	Units					Dimension (unit: mm ³)		
	Units/Reel	Reels/Inner Box	Units/Inner Box	Inner Boxes/Outer Box	Units/Outer Box	Reel	Inner Box	Outer Box
SOT-23	3,000	10	30,000	6	180,000	7" x8	180x120x180	390x385x205

Package Outline Dimensions

SOT-23

单位: mm

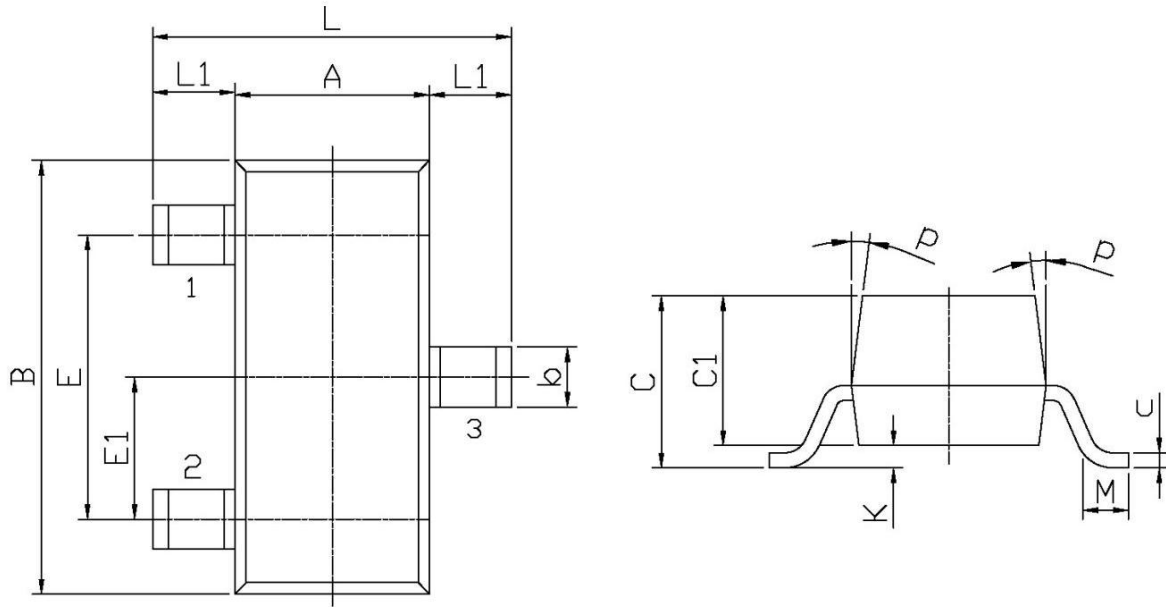

Symbol	Dimensions In Millimeters		Symbol	Dimensions In Millimeters	
	Min	Max		Min	Max
L	2.2	2.7	C	1.30Max	
L1	0.45	0.65	C1	0.90	1.20
A	1.15	1.50	c	0.05	0.20
B	2.70	3.10	K	0	0.10
E	1.70	2.10	M	0.20MIN	
E1	0.85	1.05	P	7°	
b	0.35	0.55			